



**ESTANTERÍAS /
SHELVING /
ÉTAGÈRES /
REGALE**

8.1	COMPONENTES ESTANTERÍA / SHELVING PARTS / COMPONENTS ÉTAGÈRES / REGAL KOMPONENTEN	221
8.2	KIT ESTANTERÍA / SHELVING KITS / KITS ÉTAGÈRES / REGAL SETS	225

ESTANTERÍAS MODULARES / MODULAR SHELVING / ÉTAGÈRES MODULABLES / KOMBINIERBARE REGALMODULE

-30 °C
+75 °C



FACILIDAD Y RAPIDEZ DE MONTAJE /
EASY AND QUICK ASSEMBLY /
FACILE ET RAPIDE MONTAGE /
EINFACHE UND SCHNELLE MONTAGE



ALUMINIO Y POLIPROPILENO /
ALUMINIUM AND POLYPROPYLENE /
ALUMINIUM ET POLYPROPYLÈNE /
ALUMINIUM UND POLYPROPYLEN

ANTICORROSIÓN - Fabricadas con
estructura de aluminio anodizado /
ANTICORROSIVE - Manufactured with
special anodised aluminium /
ANTI-CORROSION - Fabriquées avec
une structure en aluminium anodisé /
ANTIKORRUSION - Regale aus Spezial
eloxiertem Aluminium hergestellt

**ROBUSTEZ Y RESISTENCIA / ROBUSTNESS AND RESISTANCE /
ROBUSTESSE ET RESISTANCE / ROBUST UND RESISTENT**



**COMPATIBLE / COMPATIBILITY /
COMPATIBILITÉ / PASSEND**

GN 1/1 & 2/3

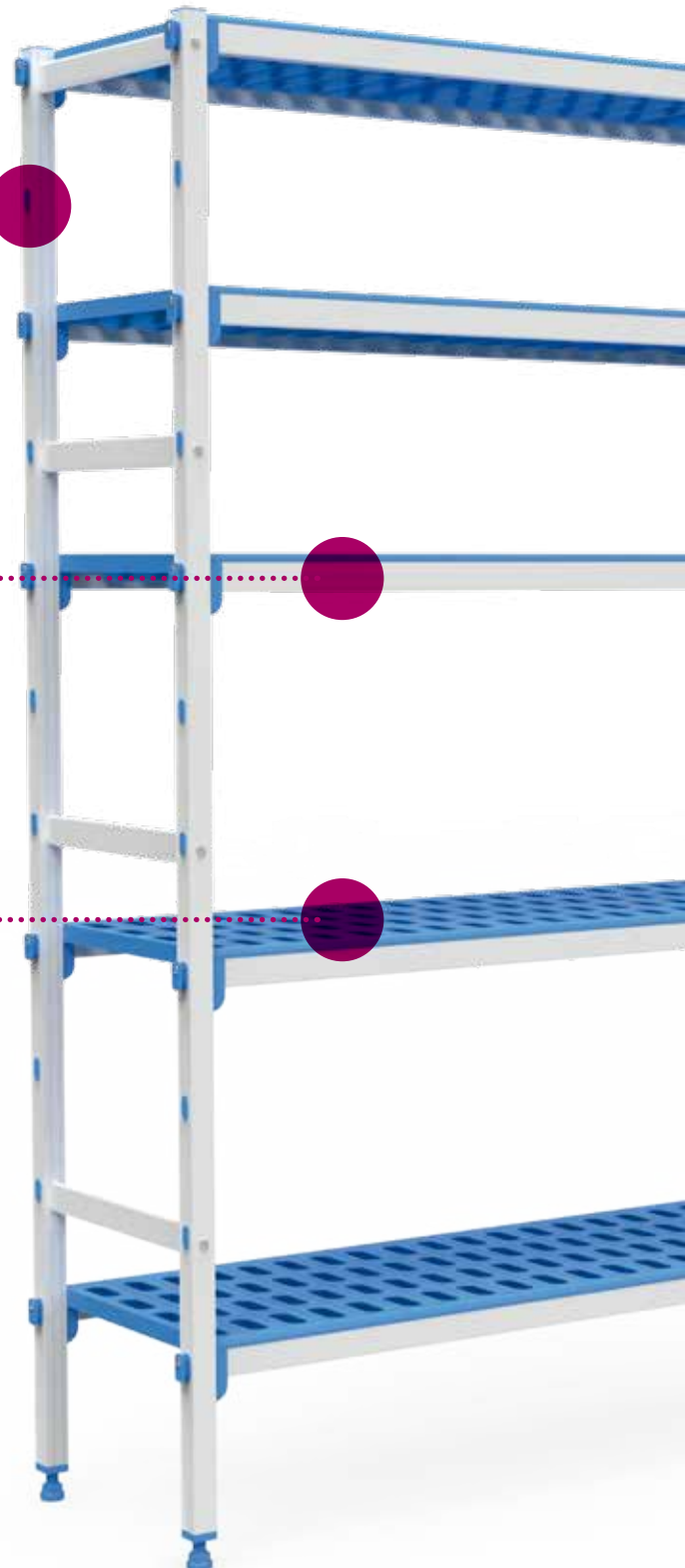

Parrillas / Rack shelves / Clayettes / Gitterböden

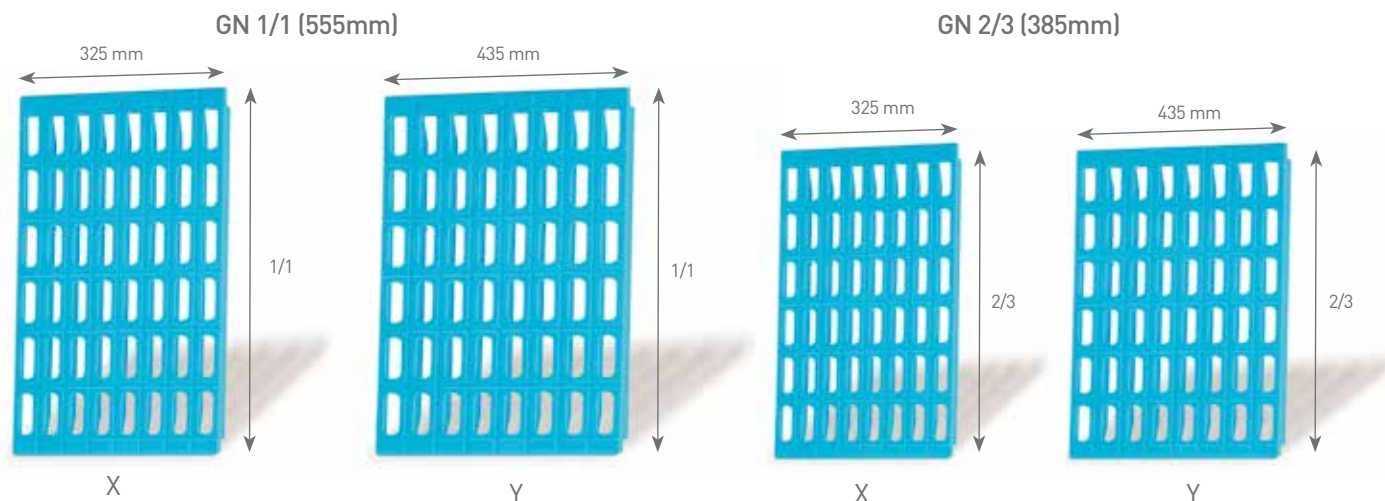

Apto para lavavajillas
Dishwasher safe
Apte pour lave-vaisselle
Geeignet für Spülmaschinen

Combinando parrillas de la misma profundidad (X/Y) permite personalizar las longitudes de las estanterías a cada una de las necesidades. (Ver en página siguiente combinaciones propuestas)

Combining rack shelves among the same group (X/Y) allows to personalize the lengths of each shelf. (Refer to next page for proposed combinations)

En combinant des clayettes du même groupe (X/Y) permet de personnaliser les longueurs des étagères à n'importe quel besoin. (Voir page suivante pour des combinaisons proposées)

Die Kombination der Gitterböden gleicher Tiefe (X/Y) erlaubt die Länge der Regale individuell je nach Bedarf zu bestimmen. (Siehe Kombinerungsvorschläge folgende Seite)

Pieza soporte travesaños / Support for crossbars / Crochet support pour largérons / Halterungsteil Traversen

Sistema especial de fijación de soporte para travesaños que ofrece la máxima seguridad, fiabilidad y robustez.

Special fixing system support for crossbars which offers the highest security, reliability and robustness.

Système spécial de fixation des supports pour longerons qui offre la sécurité, fiabilité et robustesse maximale.

Spezielles System der Halterverankerung für die Traversen, welches die höchste Sicherheit, Zuverlässigkeit und Robustheit bietet.



Pies regulables / Leveling feet / Pieds régulateurs / Regulierbare Füße

Pies regulables con rosca oculta para suelos con desniveles. Con la posibilidad de adaptar ruedas de Ø 125 mm.

Levelling feet with hidden thread, for gradient floors. It is also possible to adapt Ø 125 mm wheels.

Pieds régulateurs avec filet cache. Il est aussi possible d'y adapter des roues de Ø 125 mm.

Regulierbare Füße mit verborgenem Gewinde für unebene Böden. Mit der Möglichkeit Räder Ø 125 mm anzubringen.



Alturas estándar de los niveles / Standard heights of levels / Hauteur standard des niveaux / Standardhöhe der Ebenen

Altura 1280 mm / 3 niveles
Height 1280 mm / 3 levels
Hauteur 1280 mm / 3 niveaux
Höhe 1280 mm / 3 Ebenen

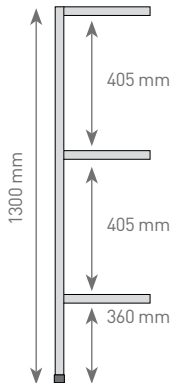

MÁS DE 2000 MM ALTURA CONSULTAR /
HIGHER THAN 2000 MM PLEASE ASK /
HAUTEUR SUPÉRIEURE À 2000 MM VEILLEZ NOUS CONSULTER /
HÖHER ALS 2000 MM BITTE FRAGEN SIE UNS

Combinaciones /
Combinations /
Combinaisons /
Kombinationen

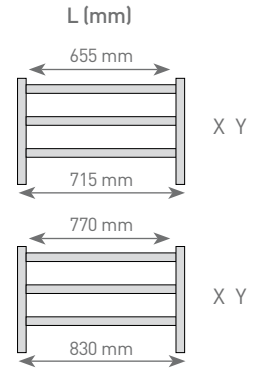

Altura 1750 mm / 3 niveles
Height 1750 mm / 3 levels
Hauteur 1750 mm / 3 niveaux
Höhe 1750 mm / 3 Ebenen

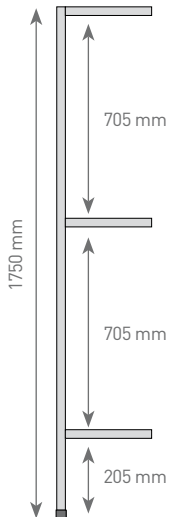

Altura 1750 mm / 4 niveles
Height 1750 mm / 4 levels
Hauteur 1750 mm / 4 niveaux
Höhe 1750 mm / 4 Ebenen

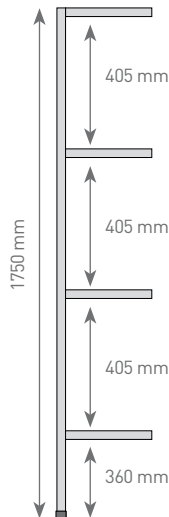

Altura 1750 mm / 5 niveles
Height 1750 mm / 5 levels
Hauteur 1750 mm / 5 niveaux
Höhe 1750 mm / 5 Ebenen

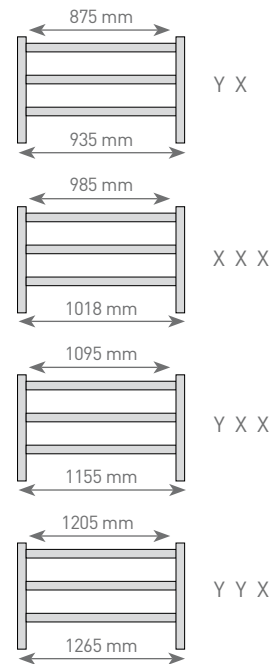
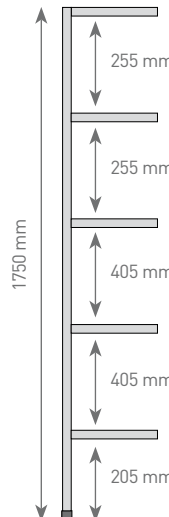

Altura 2050 mm / 4 niveles
Height 2050 mm / 4 levels
Hauteur 2050 mm / 4 niveaux
Höhe 2050 mm / 4 Ebenen

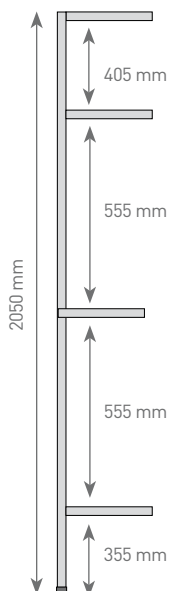

Altura 2050 mm / 5 niveles
Height 2050 mm / 5 levels
Hauteur 2050 mm / 5 niveaux
Höhe 2050 mm / 5 Ebenen

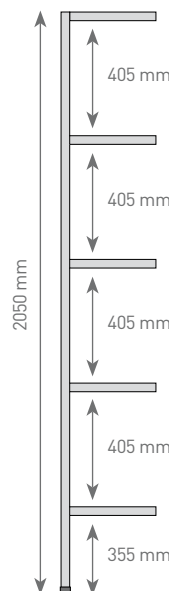

Altura 2050 mm / 6 niveles
Height 2050 mm / 6 levels
Hauteur 2050 mm / 6 niveaux
Höhe 2050 mm / 6 Ebenen

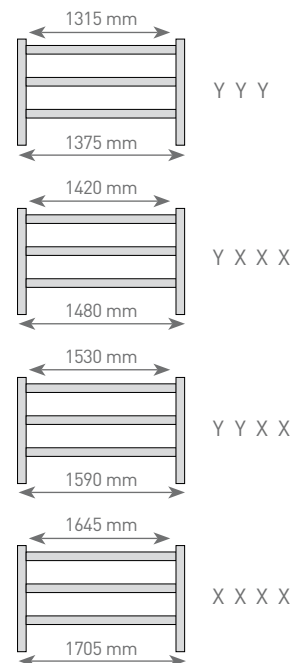
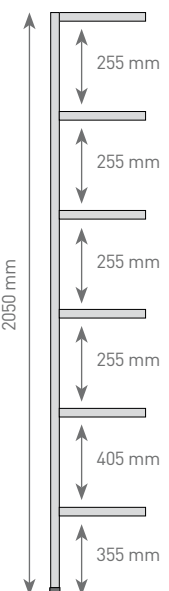

COMPONENTES /
PARTS /
COMPONENTS /
KOMPONENTEN



ESTANTERÍAS /
SHELVING /
ÉTAGÈRES

8.1 ESTANTERÍAS / SHELVING / ÉTAGÈRES / REGALE

ESTANTES (PARRILLAS + TRAVESAÑOS) /
SHELVES (RACK/SHELVES + CROSSBARS) /
NIVEAU COMPLET (CLAYETTES + LONGERONS) /
REGALE (GITTERBÖDEN + TRAVERSEN)

Fondo 385 mm. Adaptable a las cubetas gastronorm 2/3
Depth 385 mm. Suitable for 2/3 gastronorm containers
Profondeur 385 mm. Adaptable aux bacs gastronorme 2/3
Tiefe 385 mm. Passend für Gastronormbehälter 2/3

X significa una parrilla de ancho 325 mm.
Y significa una parrilla de ancho 435 mm.

X is a rack 325 mm width.
Y is a rack 435 mm width.

X est une clayette de 325 mm de largeur.
Y est une clayette de 435 mm de largeur.

X Bezeichnet einen Einlegeboden der Breite von 325 mm.
Y Bezeichnet einen Gitterboden der Breite von 435 mm.

REF	MOD	COMBINACIÓN / COMBINATION / COMBINAISON / KOMBINATION	A mm	B mm	
P7575	T61	X + X	655	385	1
P7576	T71	X + Y	770	385	1
P7577	T81	Y + Y	875	385	1
P7578	T91	X + X + X	985	385	1
P7579	T101	Y + X + X	1095	385	1
P7580	T111	Y + Y + X	1205	385	1
P7581	T131	Y + Y + Y	1315	385	1
P7582	T141	Y + X + X + X	1420	385	1
P7583	T151	Y + Y + X + X	1530	385	1
P7584	T161	Y + Y + Y + X	1645	385	1

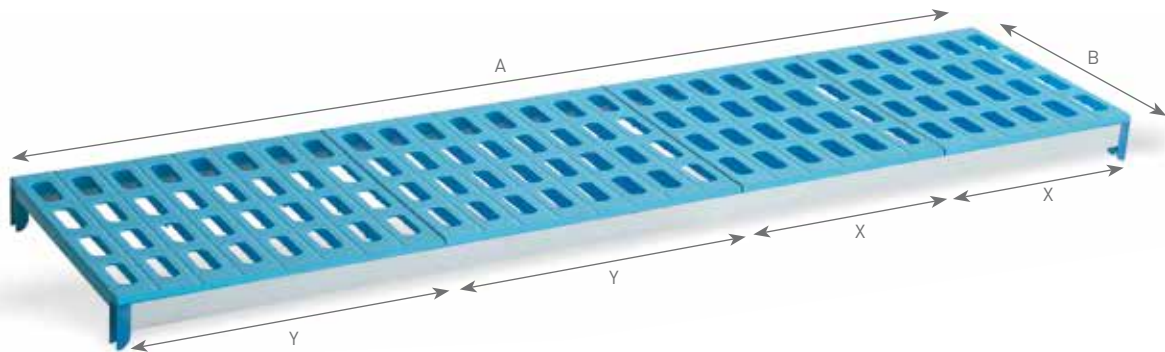

Fondo 555 mm. Adaptable a las cubetas gastronorm 1/1
Depth 555 mm. Suitable for 1/1 gastronorm containers
Profondeur 555 mm. Adaptable aux bacs gastronorme 1/1
Tiefe 555 mm. Passend für Gastronormbehälter 1/1

X significa una parrilla de ancho 325 mm.
Y significa una parrilla de ancho 435 mm.

X is a rack 325 mm width.
Y is a rack 435 mm width.

X est une clayette de 325 mm de largeur.
Y est une clayette de 435 mm de largeur.

X Bezeichnet einen Einlegeboden der Breite von 325 mm.
Y Bezeichnet einen Gitterboden der Breite von 435 mm.

REF	MOD	COMBINACIÓN / COMBINATION / COMBINAISON / KOMBINATION	A mm	B mm	
P7565	T6	X + X	655	555	1
P7566	T7	X + Y	770	555	1
P7567	T8	Y + Y	875	555	1
P7568	T9	X + X + X	985	555	1
P7569	T10	Y + X + X	1095	555	1
P7570	T11	Y + Y + X	1205	555	1
P7571	T13	Y + Y + Y	1315	555	1
P7572	T14	Y + X + X + X	1420	555	1
P7573	T15	Y + Y + X + X	1530	555	1
P7574	T16	Y + Y + Y + X	1645	555	1

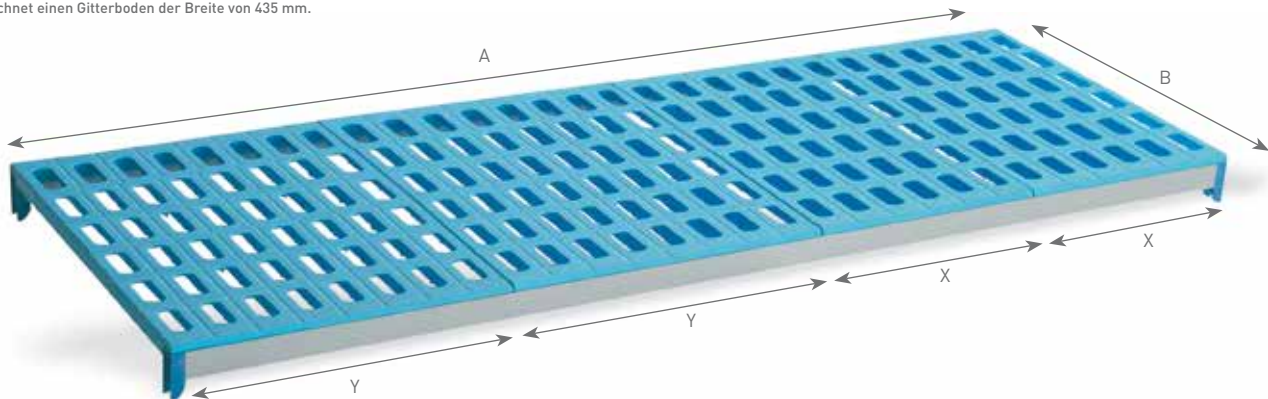

Soportes laterales / Lateral supports / Support latéraux / Seitliche Ständer



REF	MOD	A mm	B mm	NIVELES / LEVELS / NIVEAUX / EBENEN	
P7585	S1	1750	555	3	1
P7586	S2	1750	555	4	1
P7587	S3	1750	555	5	1
P7646	S0	2000	555	4	1
P7588	S4	2000	555	5	1
P7589	S5	2000	555	6	1
P7590	S6	1300	555	3	1
P7591	S7	1750	385	3	1
P7592	S8	1750	385	4	1
P7593	S9	1750	385	5	1
P7647	S13	2000	385	4	1
P7594	S10	2000	385	5	1
P7595	S11	2000	385	6	1
P7596	S12	1300	385	3	1

2 Fondos disponibles :
555 mm, gastronorm 1/1
385 mm, gastronorm 2/3

2 Available depths:
555 mm, 1/1 gastronorm
385 mm, 2/3 gastronorm

2 profondeurs disponibles:
555 mm, gastronorme 1/1
385 mm, gastronorme 2/3

2 Tiefen erhältlich:
555 mm, Gastronorm 1/1
385 mm, Gastronorm 2/3

Soportes laterales con ruedas / Lateral support with wheels / Supports latéraux avec roues / Seitliche Ständer mit Räder

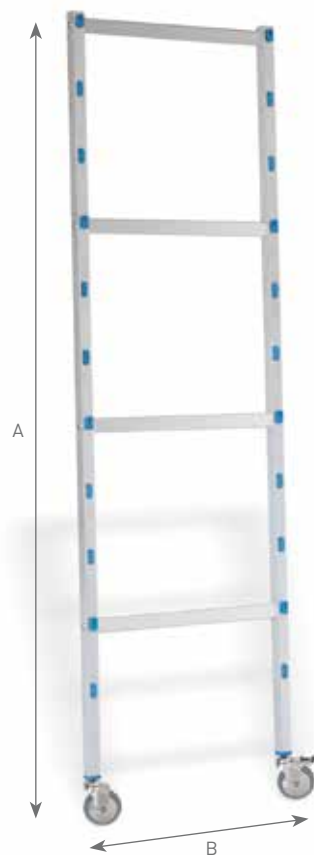

REF	A mm*	B mm	NIVELES / LEVELS / NIVEAUX / EBENEN	
P7597	1.880	555	3	1
P7598	1.880	555	4	1
P7599	1.880	555	5	1

Para montar estanterías móviles con ruedas.
To assembly mobile shelving with wheels.
Pour monter étagères mobiles avec roues.
Für die Montage von mobilen Regalen mit Räder.

* Altura con rueda incluida
* Height including wheel
* Hauteur avec la roue
* Höhe inklusive Räder

Ruedas de Ø 125 mm, dos de ellas con freno.
Wheels Ø 125 mm, two of them with brake.
Roues de Ø 125 mm, deux avec frein.
Räder Ø 125 mm, zwei von ihnen mit Bremsen.

No se recomiendan longitudes de travesaños superiores a 1400 mm.
We do not advise crossbars longer than 1400 mm.
Nous ne conseillons pas des lonerons plus longues de 1400 mm.
Wir empfehlen nicht die Länge der Traversen von 1400 mm zu überschreiten.

Soporte fijación estantería / Shelf support fixing / Support fixation étagère / Regal Fixierhalterung

N



REF	
P76.430	1

Conjunto de 2 soportes /
Two pieces kit /
Kit deux pièces /
Kit mit 2 Stück



Travesaños / Crossbars / Longérons / Traversen



REF	L mm	
P7632	655	1
P7633	770	1
P7634	875	1
P7635	985	1
P7636	1095	1
P7637	1205	1
P7638	1315	1
P7639	1420	1
P7640	1530	1
P7641	1645	1

Parrillas / Rack-shelves / Clayettes / Einlegeböden

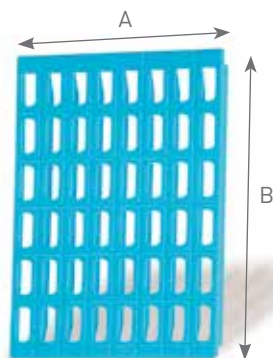

REF	TIPO / TYPE	A mm	B mm	GN Para / For / Pour / Für	
P7628	Y	435	555	1/1	1
P7629	X	325	555	1/1	1
P7630	Y	435	385	2/3	1
P7631	X	325	385	2/3	1

Ganchos para formar ángulos / Hooks to form angles /
Crochets pour faire les angles / Haken für Winkelbildung



REF	
P7642	1

Pieza soporte para travesaños / Support for crossbars /
Support pour largérons / Halterteil für Traversen



REF	
P7643	1

Bancadas / Bench / BanCS / Bänke

Diseñadas para su uso en lugares donde se prohíbe depositar cajas directamente en el suelo. Capacidad de carga de hasta 175 Kg por bancada, repartidos a lo largo de la bancada. Pie regulable para suelos desnivelados.

Designed to be used in places where it is forbidden to put boxes directly on the floor. Maximum load charge 175 Kg per bench, distributed weight throughout the bench. Leveling feet for gradient floors.

Dessinés pour être utilisés quand il est interdit de poser les boîtes directement par terre. Charge maximale 175 Kg, distribués tout au long du banc. Pieds régulateurs pour sols inégaux.

Design für den Gebrauch in Räumen, in denen es verboten ist Kisten direkt auf den Boden zu stellen. Die Tragkraft beträgt bis zu 175 Kg pro Bank, wenn die Last gleichmässig auf der Länge verteilt ist. Regulierbare Füße für unebene Böden.

REF	A mm	B mm	C mm	
P7603	715	555	280	1
P7604	830	555	280	1
P7605	935	555	280	1
P7606	1045	555	280	1
P7607	1155	555	280	1
P7608	1265	555	280	1
P7609	1375	555	280	1
P7610	1480	555	280	1
P7611	715	385	280	1
P7612	830	385	280	1
P7613	935	385	280	1
P7614	1045	385	280	1
P7615	1155	385	280	1
P7616	1260	385	280	1
P7617	1375	385	280	1
P7618	1480	385	280	1

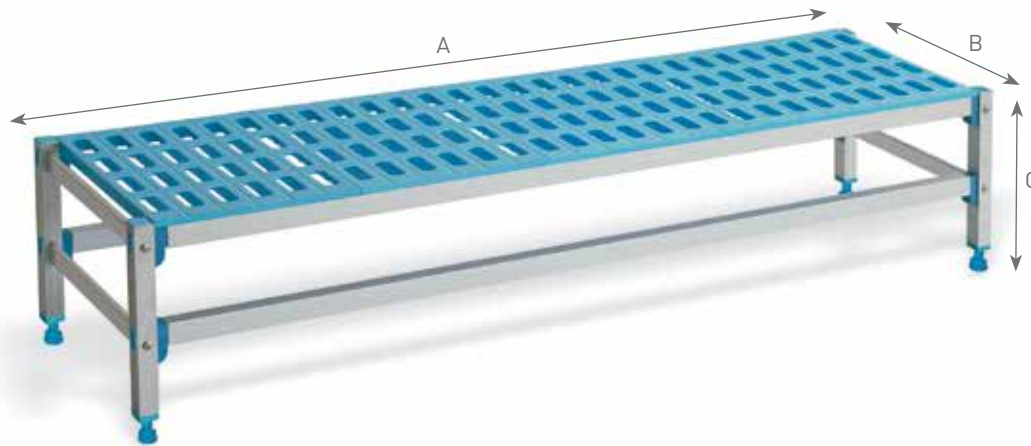

Conjunto completo con ruedas / Complet kits with wheels / Kit préparés avec roues / Komplettes Set mit Rädern



Reforzada /
Reinforced /
Renforcée /
Verstärkte

REF	A mm	B mm	C mm	TIPO / TYPE	NIVELES / LEVELS / NIVEAUX / EBENEN	
P7145R	1145	555	1880	GN 1/1	3	1
P7004R	1145	385	1880	GN 2/3	3	1
P7146R	1265	555	1880	GN 1/1	3	1
P7005R	1265	385	1880	GN 2/3	3	1
P7147R	1375	555	1880	GN 1/1	3	1
P7006R	1375	385	1880	GN 2/3	3	1

3 NIVELES /
LEVELS /
NIVEAUX /
EBENEN

Kits completos / Complete kits / Kits préparés / Komplettssets

Distintas combinaciones /
Diferent combinations /
Diferentes combinaisons /
Verschiedene Kombinationen



Compatible con cubetas 2/3 /
Compatible with 2/3 containers /
Compatible avec bacs 2/3 /
Kombinierbar mit Behältern 2/3

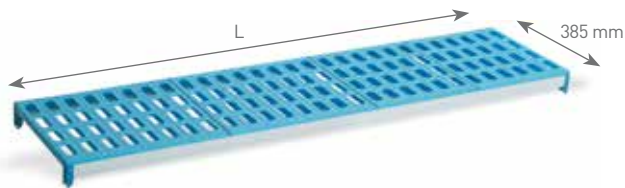

Compatible con cubetas 1/1 /
Compatible with 1/1 containers /
Compatible avec bacs 1/1 /
Kombinierbar mit Behältern 1/1

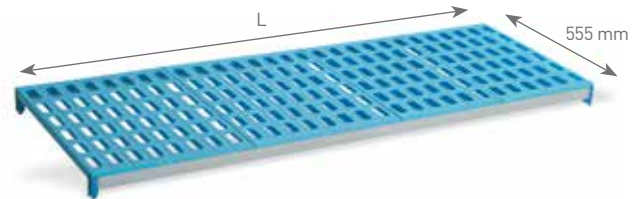

REF	L mm	REF	L mm
P7000	715	P7024	3380
P7001	830	P7025	3513
P7002	935	P7026	3621
P7003	1045	P7027	3729
P7004	1155	P7028	3841
P7005	1265	P7029	3953
P7006	1375	P7030	4065
P7007	1480	P7031	4170
P7008	1590	P7032	4275
P7009	1705	P7033	4380
P7010	1840	P7034	4490
P7011	1950	P7035	4600
P7012	2060	P7036	4710
P7013	2170	P7037	4825
P7014	2280	P7038	4940
P7015	2388	P7039	5055
P7016	2496	P7040	5186
P7017	2608	P7041	5298
P7018	2720	P7042	5410
P7019	2825	P7043	5515
P7020	2930	P7044	5620
P7021	3040	P7045	5725
P7022	3150	P7046	5830
P7023	3265		

REF	L mm	REF	L mm
P7141	715	P7165	3380
P7142	830	P7166	3513
P7143	935	P7167	3621
P7144	1045	P7168	3729
P7145	1155	P7169	3841
P7146	1263	P7170	3953
P7147	1375	P7171	4065
P7148	1480	P7172	4170
P7149	1590	P7173	4275
P7150	1705	P7174	4380
P7151	1840	P7175	4490
P7152	1950	P7176	4600
P7153	2060	P7177	4710
P7154	2170	P7178	4825
P7155	2280	P7179	4940
P7156	2388	P7180	5055
P7157	2496	P7181	5186
P7158	2608	P7182	5298
P7159	2720	P7183	5410
P7160	2825	P7184	5515
P7161	2930	P7185	5620
P7162	3040	P7186	5725
P7163	3150	P7187	5830
P7164	3265		

3 NIVELES /
LEVELS /
NIVEAUX /
EBENEN

Estanterías angulares / Shelvings for angle / Étagères angulaires / Rechtwinklige Regale

Distintas combinaciones /
Diferent combinations /
Diferentes combinaisons /
Verschiedene Kombinationen



Incluido / Included / Compris / Inklusive:
Ganchos para formar ángulos /
Hooks to form angles /
Crochets pour faire les angles /
Haken für Winkelbildung

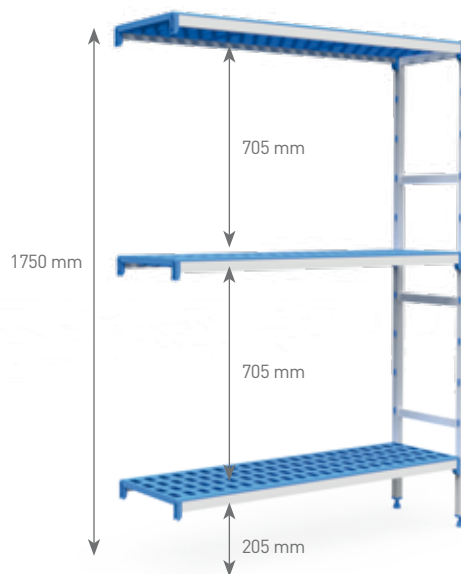

Compatible con cubetas 2/3 /
Compatible with 2/3 containers /
Compatible avec bacs 2/3 /
Kombinierbar mit Behältern 2/3

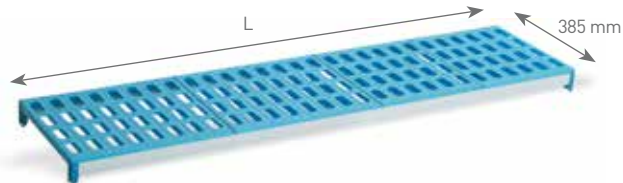

Compatible con cubetas 1/1 /
Compatible with 1/1 containers /
Compatible avec bacs 1/1 /
Kombinierbar mit Behältern 1/1

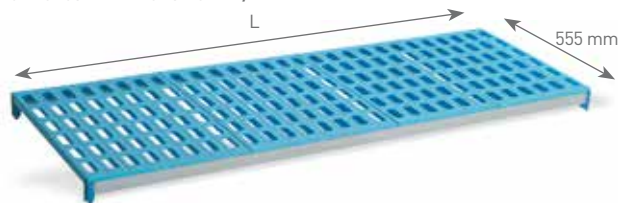

REF	L mm
P7282	685
P7283	800
P7284	905
P7285	1015
P7286	1125
P7287	1233
P7288	1345
P7289	1450
P7290	1560
P7291	1675
P7292	1810
P7293	1920
P7294	2030
P7295	2140
P7296	2250
P7297	2358
P7298	2466
P7299	2578
P7300	2690
P7301	2795
P7302	2900
P7303	3010
P7304	3120
P7305	3235

REF	L mm
P7306	3350
P7307	3483
P7308	3591
P7309	3699
P7310	3811
P7311	3923
P7312	4035
P7313	4140
P7314	4245
P7315	4350
P7316	4460
P7317	4570
P7318	4680
P7319	4795
P7320	4910
P7321	5025
P7322	5156
P7323	5268
P7324	5380
P7325	5485
P7326	5590
P7327	5695
P7328	5800

REF	L mm
P7423	685
P7424	800
P7425	905
P7426	1015
P7427	1125
P7428	1233
P7429	1345
P7430	1450
P7431	1560
P7432	1675
P7433	1810
P7434	1920
P7435	2030
P7436	2140
P7437	2250
P7438	2358
P7439	2466
P7440	2578
P7441	2690
P7442	2795
P7443	2900
P7444	3010
P7445	3120
P7446	3235

REF	L mm
P7447	3350
P7448	3483
P7449	3591
P7450	3699
P7451	3811
P7452	3923
P7453	4035
P7454	4140
P7455	4245
P7456	4350
P7457	4460
P7458	4570
P7459	4680
P7460	4795
P7461	4910
P7462	5025
P7463	5156
P7464	5268
P7465	5380
P7466	5485
P7467	5590
P7468	5695
P7469	5800

ESTANTERÍAS /
SHELVING /
ÉTAGÈRES

4 NIVELES /
LEVELS /
NIVEAUX /
EBENEN

Kits completos / Complete kits / Kits préparés / Komplettssets

Distintas combinaciones /
Diferent combinations /
Diferentes combinaisons /
Verschiedene Kombinationen



Compatible con cubetas 2/3 /
Compatible with 2/3 containers /
Compatible avec bacs 2/3 /
Kombinierbar mit Behältern 2/3

Compatible con cubetas 1/1 /
Compatible with 1/1 containers /
Compatible avec bacs 1/1 /
Kombinierbar mit Behältern 1/1

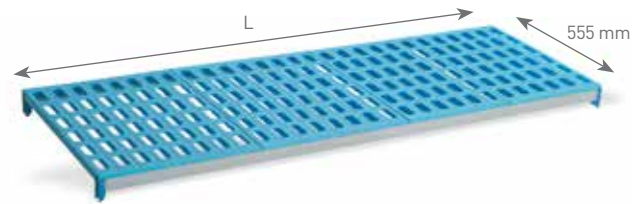
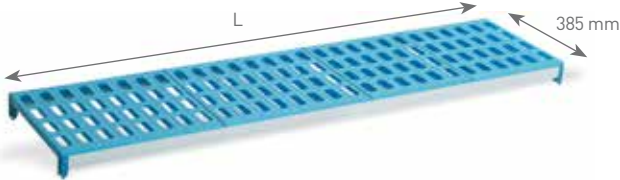

REF	L mm	REF	L mm
P7047	715	P7071	3380
P7048	830	P7072	3513
P7049	935	P7073	3621
P7050	1045	P7074	3729
P7051	1155	P7075	3841
P7052	1263	P7076	3953
P7053	1375	P7077	4065
P7054	1480	P7078	4170
P7055	1590	P7079	4275
P7056	1705	P7080	4380
P7057	1840	P7081	4490
P7058	1950	P7082	4600
P7059	2060	P7083	4710
P7060	2170	P7084	4825
P7061	2280	P7085	4940
P7062	2388	P7086	5055
P7063	2496	P7087	5186
P7064	2608	P7088	5298
P7065	2720	P7089	5410
P7066	2825	P7090	5515
P7067	2930	P7091	5620
P7068	3040	P7092	5725
P7069	3150	P7093	5830
P7070	3265		

REF	L mm	REF	L mm
P7188	715	P7212	3380
P7189	830	P7213	3513
P7190	935	P7214	3621
P7191	1045	P7215	3729
P7192	1155	P7216	3841
P7193	1263	P7217	3953
P7194	1375	P7218	4065
P7195	1480	P7219	4170
P7196	1590	P7220	4275
P7197	1705	P7221	4380
P7198	1840	P7222	4490
P7199	1950	P7223	4600
P7200	2060	P7224	4710
P7201	2170	P7225	4825
P7202	2280	P7226	4940
P7203	2388	P7227	5055
P7204	2496	P7228	5186
P7205	2608	P7229	5298
P7206	2720	P7230	5410
P7207	2825	P7231	5515
P7208	2930	P7232	5620
P7209	3040	P7233	5725
P7210	3150	P7234	5830
P7211	3265		

4 NIVELES /
LEVELS /
NIVEAUX /
EBEBEN

Estanterías angulares / Shelvings for angle / Étagères angulaires / Rechtwinklige Regale

Distintas combinaciones /
Diferent combinations /
Diferentes combinaisons /
Verschiedene Kombinationen



Incluido / Included / Compris / Inklusive:
Ganchos para formar ángulos /
Hooks to form angles /
Crochets pour faire les angles /
Haken für Winkelbildung



Compatible con cubetas 2/3 /
Compatible with 2/3 containers /
Compatible avec bacs 2/3 /
Kombinierbar mit Behältern 2/3

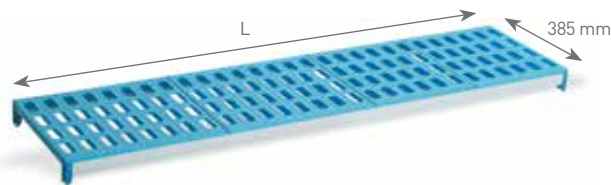

Compatible con cubetas 1/1 /
Compatible with 1/1 containers /
Compatible avec bacs 1/1 /
Kombinierbar mit Behältern 1/1

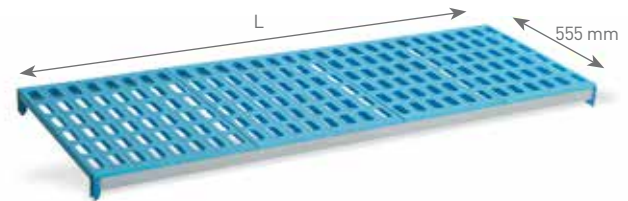

REF	L mm
P7329	685
P7330	800
P7331	905
P7332	1015
P7333	1125
P7334	1233
P7335	1345
P7336	1450
P7337	1560
P7338	1675
P7339	1810
P7340	1920
P7341	2030
P7342	2140
P7343	2250
P7344	2358
P7345	2466
P7346	2578
P7347	2690
P7348	2795
P7349	2900
P7350	3010
P7351	3120
P7352	3235

REF	L mm
P7353	3350
P7354	3483
P7355	3591
P7356	3699
P7357	3811
P7358	3923
P7359	4035
P7360	4140
P7361	4245
P7362	4350
P7363	4460
P7364	4570
P7365	4680
P7366	4795
P7367	4910
P7368	5025
P7369	5156
P7370	5268
P7371	5380
P7372	5485
P7373	5590
P7374	5695
P7375	5800

REF	L mm
P7470	685
P7471	800
P7472	905
P7473	1015
P7474	1125
P7475	1233
P7476	1345
P7477	1450
P7478	1560
P7479	1675
P7480	1810
P7481	1920
P7482	2030
P7483	2140
P7484	2250
P7485	2358
P7486	2466
P7487	2578
P7488	2690
P7489	2795
P7490	2900
P7491	3010
P7492	3120
P7493	3235

REF	L mm
P7494	3350
P7495	3483
P7496	3591
P7497	3699
P7498	3811
P7499	3923
P7500	4035
P7501	4140
P7502	4245
P7503	4350
P7504	4460
P7505	4570
P7506	4680
P7507	4795
P7508	4910
P7509	5025
P7510	5156
P7511	5268
P7512	5380
P7513	5485
P7514	5590
P7515	5695
P7516	5800

5 NIVELES /
LEVELS /
NIVEAUX /
EBENEN

Kits completos / Complete kits / Kits préparés / Komplettssets

Distintas combinaciones /
Diferent combinations /
Diferentes combinaisons /
Verschiedene Kombinationen



Compatible con cubetas 2/3 /
Compatible with 2/3 containers /
Compatible avec bacs 2/3 /
Kombinierbar mit Behältern 2/3

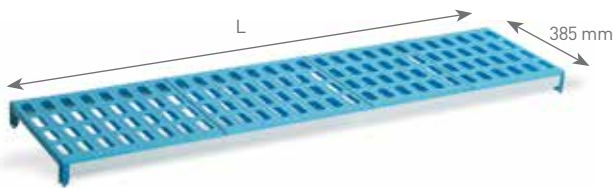

Compatible con cubetas 1/1 /
Compatible with 1/1 containers /
Compatible avec bacs 1/1 /
Kombinierbar mit Behältern 1/1

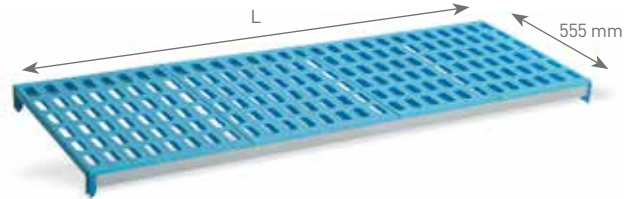

REF	L mm
P7094	715
P7095	830
P7096	935
P7097	1045
P7098	1155
P7099	1263
P7100	1375
P7101	1480
P7102	1590
P7103	1705
P7104	1840
P7105	1950
P7106	2060
P7107	2170
P7108	2280
P7109	2388
P7110	2496
P7111	2608
P7112	2720
P7113	2825
P7114	2930
P7115	3040
P7116	3150
P7117	3265

REF	L mm
P7118	3380
P7119	3513
P7120	3621
P7121	3729
P7122	3841
P7123	3953
P7124	4065
P7125	4170
P7126	4275
P7127	4380
P7128	4490
P7129	4600
P7130	4710
P7131	4825
P7132	4940
P7133	5055
P7134	5186
P7135	5298
P7136	5410
P7137	5515
P7138	5620
P7139	5725
P7140	5830

REF	L mm
P7235	715
P7236	830
P7237	935
P7238	1045
P7239	1155
P7240	1263
P7241	1375
P7242	1480
P7243	1590
P7244	1705
P7245	1840
P7246	1950
P7247	2060
P7248	2170
P7249	2280
P7250	2388
P7251	2496
P7252	2608
P7253	2720
P7254	2825
P7255	2930
P7256	3040
P7257	3150
P7258	3265

REF	L mm
P7259	3380
P7260	3513
P7261	3621
P7262	3729
P7263	3841
P7264	3953
P7265	4065
P7266	4170
P7267	4275
P7268	4380
P7269	4490
P7270	4600
P7271	4710
P7272	4825
P7273	4940
P7274	5055
P7275	5186
P7276	5298
P7277	5410
P7278	5515
P7279	5620
P7280	5725
P7281	5830

5 NIVELES /
LEVELS /
NIVEAUX /
EBENEN

Estanterías angulares / Shelvings for angle / Étagères angulaires / Rechtwinklige Regale

Distintas combinaciones /
Diferent combinations /
Diferentes combinaisons /
Verschiedene Kombinationen



Incluido / Included / Compris / Inklusive:
Ganchos para formar ángulos /
Hooks to form angles /
Crochets pour faire les angles /
Haken für Winkelbildung



Compatible con cubetas 2/3 /
Compatible with 2/3 containers /
Compatible avec bacs 2/3 /
Kombinierbar mit Behältern 2/3

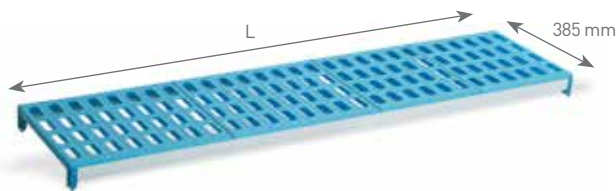

REF	L mm	REF	L mm
P7376	685	P7400	3350
P7377	800	P7401	3483
P7378	905	P7402	3591
P7379	1015	P7403	3699
P7380	1125	P7404	3811
P7381	1233	P7405	3923
P7382	1345	P7406	4035
P7383	1450	P7407	4140
P7384	1560	P7408	4245
P7385	1675	P7409	4350
P7386	1810	P7410	4460
P7387	1920	P7411	4570
P7388	2030	P7412	4680
P7389	2140	P7413	4795
P7390	2250	P7414	4910
P7391	2358	P7415	5025
P7392	2466	P7416	5156
P7393	2578	P7417	5268
P7394	2690	P7418	5380
P7395	2795	P7419	5485
P7396	2900	P7420	5590
P7397	3010	P7421	5695
P7398	3120	P7422	5800
P7399	3235		



Compatible con cubetas 1/1 /
Compatible with 1/1 containers /
Compatible avec bacs 1/1 /
Kombinierbar mit Behältern 1/1

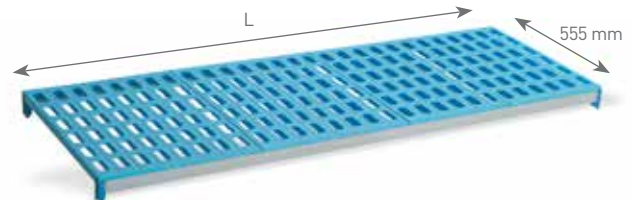

REF	L mm	REF	L mm
P7517	685	P7541	3350
P7518	800	P7542	3483
P7519	905	P7543	3591
P7520	1015	P7544	3699
P7521	1125	P7545	3811
P7522	1233	P7546	3923
P7523	1345	P7547	4035
P7524	1450	P7548	4140
P7525	1560	P7549	4245
P7526	1675	P7550	4350
P7527	1810	P7551	4460
P7528	1920	P7552	4570
P7529	2030	P7553	4680
P7530	2140	P7554	4795
P7531	2250	P7555	4910
P7532	2358	P7556	5025
P7533	2466	P7557	5156
P7534	2578	P7558	5268
P7535	2690	P7559	5380
P7536	2795	P7560	5485
P7537	2900	P7561	5590
P7538	3010	P7562	5695
P7539	3120		5800
P7540	3235		

FONDO 385 mm. Adaptable a GASTRONORM 2/3 / DEEPth 385 mm. Suitable for 2/3 GASTRONORM /
PROFONDEUR 385 mm. Adaptable aux GASTRONORME 2/3 / Tiefe 385 mm. Passend für Gastronorm 2/3

REF. 3 niveles 3 levels 3 niveaux 3 Ebenen	DESGLOSE BREAKDOWN COMPOSITION AUFLISTUNG
P7000	2 S7 + 3 T61
P7001	2 S7 + 3 T71
P7002	2 S7 + 3 T81
P7003	2 S7 + 3 T91
P7004	2 S7 + 3 T101
P7005	2 S7 + 3 T111
P7006	2 S7 + 3 T131
P7007	2 S7 + 3 T141
P7008	2 S7 + 3 T151
P7009	2 S7 + 3 T161
P7010	3 S7 + 6 T81
P7011	3 S7 + 3 T81 + 3 T91
P7012	3 S7 + 6 T91
P7013	3 S7 + 3 T91 + 3 T101
P7014	3 S7 + 6 T101
P7015	3 S7 + 3 T101 + 3 T111
P7016	3 S7 + 6 T111
P7017	3 S7 + 3 T111 + 3 T131
P7018	3 S7 + 6 T131
P7019	3 S7 + 3 T131 + 3 T141
P7020	3 S7 + 6 T141
P7021	3 S7 + 3 T141 + 3 T151
P7022	3 S7 + 6 T151
P7023	3 S7 + 3 T151 + 3 T161
P7024	3 S7 + 6 T161
P7025	4 S7 + 6 T101 + 3 T111
P7026	4 S7 + 3 T101 + 6 T111
P7027	4 S7 + 9 T111
P7028	4 S7 + 6 T111 + 3 T131
P7029	4 S7 + 3 T111 + 6 T131
P7030	4 S7 + 9 T131
P7031	4 S7 + 6 T131 + 3 T141
P7032	4 S7 + 3 T131 + 6 T141
P7033	4 S7 + 9 T141
P7034	4 S7 + 6 T141 + 3 T151
P7035	4 S7 + 3 T141 + 6 T151
P7036	4 S7 + 9 T151
P7037	4 S7 + 6 T151 + 3 T161
P7038	4 S7 + 3 T151 + 6 T161
P7039	4 S7 + 9 T161
P7040	5 S7 + 6 T111 + 6 T131
P7041	5 S7 + 3 T111 + 9 T131
P7042	5 S7 + 12 T131
P7043	5 S7 + 3 T141 + 9 T131
P7044	5 S7 + 6 T131 + 6 T141
P7045	5 S7 + 3 T131 + 9 T141
P7046	5 S7 + 12 T141

REF. 4 niveles 4 levels 4 niveaux 4 Ebenen	DESGLOSE BREAKDOWN COMPOSITION AUFLISTUNG
P7047	2 S8 + 4 T61
P7048	2 S8 + 4 T71
P7049	2 S8 + 4 T81
P7050	2 S8 + 4 T91
P7051	2 S8 + 4 T101
P7052	2 S8 + 4 T111
P7053	2 S8 + 4 T131
P7054	2 S8 + 4 T141
P7055	2 S8 + 4 T151
P7056	2 S8 + 4 T161
P7057	3 S8 + 8 T81
P7058	3 S8 + 4 T81 + 4 T91
P7059	3 S8 + 8 T91
P7060	3 S8 + 4 T91 + 4 T101
P7061	3 S8 + 8 T101
P7062	3 S8 + 4 T101 + 4 T111
P7063	3 S8 + 8 T111
P7064	3 S8 + 4 T111 + 4 T131
P7065	3 S8 + 8 T131
P7066	3 S8 + 4 T131 + 4 T141
P7067	3 S8 + 8 T141
P7068	3 S8 + 4 T141 + 4 T151
P7069	3 S8 + 8 T151
P7070	3 S8 + 4 T151 + 4 T161
P7071	3 S8 + 8 T161
P7072	4 S8 + 8 T101 + 4 T111
P7073	4 S8 + 4 T101 + 8 T111
P7074	4 S8 + 12 T111
P7075	4 S8 + 8 T111 + 4 T131
P7076	4 S8 + 4 T111 + 8 T131
P7077	4 S8 + 12 T131
P7078	4 S8 + 8 T131 + 4 T141
P7079	4 S8 + 4 T131 + 8 T141
P7080	4 S8 + 12 T141
P7081	4 S8 + 8 T141 + 4 T151
P7082	4 S8 + 4 T141 + 8 T151
P7083	4 S8 + 12 T151
P7084	4 S8 + 8 T151 + 4 T161
P7085	4 S8 + 4 T151 + 8 T161
P7086	4 S8 + 12 T161
P7087	5 S8 + 8 T111 + 8 T131
P7088	5 S8 + 4 T111 + 12 T131
P7089	5 S8 + 16 T131
P7090	5 S8 + 4 T141 + 12 T131
P7091	5 S8 + 8 T131 + 8 T141
P7092	5 S8 + 4 T131 + 12 T141
P7093	5 S8 + 16 T141

REF. 5 niveles 5 levels 5 niveaux 5 Ebenen	DESGLOSE BREAKDOWN COMPOSITION AUFLISTUNG
P7094	2 S9 + 5 T61
P7095	2 S9 + 5 T71
P7096	2 S9 + 5 T81
P7097	2 S9 + 5 T91
P7098	2 S9 + 5 T101
P7099	2 S9 + 5 T111
P7100	2 S9 + 5 T131
P7101	2 S9 + 5 T141
P7102	2 S9 + 5 T151
P7103	2 S9 + 5 T161
P7104	3 S9 + 10 T81
P7105	3 S9 + 5 T81 + 5 T91
P7106	3 S9 + 10 T91
P7107	3 S9 + 5 T91 + 5 T101
P7108	3 S9 + 10 T101
P7109	3 S9 + 5 T101 + 5 T111
P7110	3 S9 + 10 T111
P7111	3 S9 + 5 T111 + 5 T131
P7112	3 S9 + 10 T131
P7113	3 S9 + 5 T131 + 5 T141
P7114	3 S9 + 10 T141
P7115	3 S9 + 5 T141 + 5 T151
P7116	3 S9 + 10 T151
P7117	3 S9 + 5 T151 + 5 T161
P7118	3 S9 + 10 T161
P7119	4 S9 + 10 T101 + 5 T111
P7120	4 S9 + 5 T101 + 10 T111
P7121	4 S9 + 15 T111
P7122	4 S9 + 10 T111 + 5 T131
P7123	4 S9 + 5 T111 + 10 T131
P7124	4 S9 + 15 T131
P7125	4 S9 + 10 T131 + 5 T141
P7126	4 S9 + 5 T131 + 10 T141
P7127	4 S9 + 15 T141
P7128	4 S9 + 10 T141 + 5 T151
P7129	4 S9 + 5 T141 + 10 T151
P7130	4 S9 + 15 T151
P7131	4 S9 + 10 T151 + 5 T161
P7132	4 S9 + 5 T151 + 10 T161
P7133	4 S9 + 15 T161
P7134	5 S9 + 10 T111 + 10 T131
P7135	5 S9 + 5 T111 + 15 T131
P7136	5 S9 + 20 T131
P7137	5 S9 + 5 T141 + 15 T131
P7138	5 S9 + 10 T131 + 10 T141
P7139	5 S9 + 5 T131 + 15 T141
P7140	5 S9 + 20 T141

FONDO 555 mm. Adaptable a GASTRONORM 1/1 / DEPTH 555 mm. Suitable for 1/1 GASTRONORM /
PROFONDEUR 555 mm. Adaptable aux GASTRONORME 1/1 / Tiefe 555 mm. Passend für Gastronorm 1/1

REF. 3 niveles 3 levels 3 niveaux 3 Ebenen	DESGLOSE BREAKDOWN COMPOSITION AUFLISTUNG	REF. 4 niveles 4 levels 4 niveaux 4 Ebenen	DESGLOSE BREAKDOWN COMPOSITION AUFLISTUNG	REF. 5 niveles 5 levels 5 niveaux 5 Ebenen	DESGLOSE BREAKDOWN COMPOSITION AUFLISTUNG
P7141	2 S1 + 3 T6	P7188	2 S2 + 4 T6	P7235	2 S3 + 5 T6
P7142	2 S1 + 3 T7	P7189	2 S2 + 4 T7	P7236	2 S3 + 5 T7
P7143	2 S1 + 3 T8	P7190	2 S2 + 4 T8	P7237	2 S3 + 5 T8
P7144	2 S1 + 3 T9	P7191	2 S2 + 4 T9	P7238	2 S3 + 5 T9
P7145	2 S1 + 3 T10	P7192	2 S2 + 4 T10	P7239	2 S3 + 5 T10
P7146	2 S1 + 3 T11	P7193	2 S2 + 4 T11	P7240	2 S3 + 5 T11
P7147	2 S1 + 3 T13	P7194	2 S2 + 4 T13	P7241	2 S3 + 5 T13
P7148	2 S1 + 3 T14	P7195	2 S2 + 4 T14	P7242	2 S3 + 5 T14
P7149	2 S1 + 3 T15	P7196	2 S2 + 4 T15	P7243	2 S3 + 5 T15
P7150	2 S1 + 3 T16	P7197	2 S2 + 4 T16	P7244	2 S3 + 5 T16
P7151	3 S1 + 6 T8	P7198	3 S2 + 8 T8	P7245	3 S3 + 10 T8
P7152	3 S1 + 3 T8 + 3 T9	P7199	3 S2 + 4 T8 + 4 T9	P7246	3 S3 + 5 T8 + 5 T9
P7153	3 S1 + 6 T9	P7200	3 S2 + 8 T9	P7247	3 S3 + 10 T9
P7154	3 S1 + 3 T9 + 3 T10	P7201	3 S2 + 4 T9 + 4 T10	P7248	3 S3 + 5 T9 + 5 T10
P7155	3 S1 + 6 T10	P7202	3 S2 + 8 T10	P7249	3 S3 + 10 T10
P7156	3 S1 + 3 T10 + 3 T11	P7203	3 S2 + 4 T10 + 4 T11	P7250	3 S3 + 5 T10 + 5 T11
P7157	3 S1 + 6 T11	P7204	3 S2 + 8 T11	P7251	3 S3 + 10 T11
P7158	3 S1 + 3 T11 + 3 T13	P7205	3 S2 + 4 T11 + 4 T13	P7252	3 S3 + 5 T11 + 5 T13
P7159	3 S1 + 6 T13	P7206	3 S2 + 8 T13	P7253	3 S3 + 10 T13
P7160	3 S1 + 3 T13 + 3 T14	P7207	3 S2 + 4 T13 + 4 T14	P7254	3 S3 + 5 T13 + 5 T14
P7161	3 S1 + 6 T14	P7208	3 S2 + 8 T14	P7255	3 S3 + 10 T14
P7162	3 S1 + 3 T14 + 3 T15	P7209	3 S2 + 4 T14 + 4 T15	P7256	3 S3 + 5 T14 + 5 T15
P7163	3 S1 + 6 T15	P7210	3 S2 + 8 T15	P7257	3 S3 + 10 T15
P7164	3 S1 + 3 T15 + 3 T16	P7211	3 S2 + 4 T15 + 4 T16	P7258	3 S3 + 5 T15 + 5 T16
P7165	3 S1 + 6 T16	P7212	3 S2 + 8 T16	P7259	3 S3 + 10 T16
P7166	4 S1 + 6 T10 + 3 T11	P7213	4 S2 + 8 T10 + 4 T11	P7260	4 S3 + 10 T10 + 5 T11
P7167	4 S1 + 3 T10 + 6 T11	P7214	4 S2 + 4 T10 + 8 T11	P7261	4 S3 + 5 T10 + 10 T11
P7168	4 S1 + 9 T11	P7215	4 S2 + 12 T11	P7262	4 S3 + 15 T11
P7169	4 S1 + 6 T11 + 3 T13	P7216	4 S2 + 8 T11 + 4 T13	P7263	4 S3 + 10 T11 + 5 T13
P7170	4 S1 + 3 T11 + 6 T13	P7217	4 S2 + 4 T11 + 8 T13	P7264	4 S3 + 5 T11 + 10 T13
P7171	4 S1 + 9 T13	P7218	4 S2 + 12 T13	P7265	4 S3 + 15 T13
P7172	4 S1 + 6 T13 + 3 T14	P7219	4 S2 + 8 T13 + 4 T14	P7266	4 S3 + 10 T13 + 5 T14
P7173	4 S1 + 3 T13 + 6 T14	P7220	4 S2 + 4 T13 + 8 T14	P7267	4 S3 + 5 T13 + 10 T14
P7174	4 S1 + 9 T14	P7221	4 S2 + 12 T14	P7268	4 S3 + 15 T14
P7175	4 S1 + 6 T14 + 3 T15	P7222	4 S2 + 8 T14 + 4 T15	P7269	4 S3 + 10 T14 + 5 T15
P7176	4 S1 + 3 T14 + 6 T15	P7223	4 S2 + 4 T14 + 8 T15	P7270	4 S3 + 5 T14 + 10 T15
P7177	4 S1 + 9 T15	P7224	4 S2 + 12 T15	P7271	4 S3 + 15 T15
P7178	4 S1 + 6 T15 + 3 T16	P7225	4 S2 + 8 T15 + 4 T16	P7272	4 S3 + 10 T15 + 5 T16
P7179	4 S1 + 3 T15 + 6 T16	P7226	4 S2 + 4 T15 + 8 T16	P7273	4 S3 + 5 T15 + 10 T16
P7180	4 S1 + 9 T16	P7227	4 S2 + 12 T16	P7274	4 S3 + 15 T16
P7181	5 S1 + 6 T11 + 6 T13	P7228	5 S2 + 8 T11 + 8 T13	P7275	5 S3 + 10 T11 + 10 T13
P7182	5 S1 + 3 T11 + 9 T13	P7229	5 S2 + 4 T11 + 12 T13	P7276	5 S3 + 5 T11 + 15 T13
P7183	5 S1 + 12 T13	P7230	5 S2 + 16 T13	P7277	5 S3 + 20 T13
P7184	5 S1 + 3 T14 + 9 T13	P7231	5 S2 + 4 T14 + 12 T13	P7278	5 S3 + 5 T14 + 15 T13
P7185	5 S1 + 6 T13 + 6 T14	P7232	5 S2 + 8 T13 + 8 T14	P7279	5 S3 + 10 T13 + 10 T14
P7186	5 S1 + 3 T13 + 9 T14	P7233	5 S2 + 4 T13 + 12 T14	P7280	5 S3 + 5 T13 + 15 T14
P7187	5 S1 + 12 T14	P7234	5 S2 + 16 T14	P7281	5 S3 + 20 T14

FONDO 385 mm. Adaptable a GASTRONORM 2/3 / DEEPTH 385 mm. Suitable for 2/3 GASTRONORM /
PROFONDEUR 385 mm. Adaptable aux GASTRONORME 2/3 / Tiefe 385 mm. Passend für Gastronorm 2/3

REF. 3 niveles 3 levels 3 niveaux 3 Ebenen	DESGLOSE BREAKDOWN COMPOSITION AUFLISTUNG
P7282	1 S7 + 3 T61
P7283	1 S7 + 3 T71
P7284	1 S7 + 3 T81
P7285	1 S7 + 3 T91
P7286	1 S7 + 3 T101
P7287	1 S7 + 3 T111
P7288	1 S7 + 3 T131
P7289	1 S7 + 3 T141
P7290	1 S7 + 3 T151
P7291	1 S7 + 3 T161
P7292	2 S7 + 6 T81
P7293	2 S7 + 3 T81 + 3 T91
P7294	2 S7 + 6 T91
P7295	2 S7 + 3 T91 + 3 T101
P7296	2 S7 + 6 T101
P7297	2 S7 + 3 T111 + 3 T111
P7298	2 S7 + 6 T111
P7299	2 S7 + 3 T111 + 3 T131
P7300	2 S7 + 6 T131
P7301	2 S7 + 3 T131 + 3 T141
P7302	2 S7 + 6 T141
P7303	2 S7 + 3 T141 + 3 T151
P7304	2 S7 + 6 T151
P7305	2 S7 + 3 T151 + 3 T161
P7306	2 S7 + 6 T161
P7307	3 S7 + 6 T101 + 3 T111
P7308	3 S7 + 3 T101 + 6 T111
P7309	3 S7 + 9 T111
P7310	3 S7 + 6 T111 + 3 T131
P7311	3 S7 + 3 T111 + 6 T131
P7312	3 S7 + 9 T131
P7313	3 S7 + 6 T131 + 3 T141
P7314	3 S7 + 3 T131 + 6 T141
P7315	3 S7 + 9 T141
P7316	3 S7 + 6 T141 + 3 T151
P7317	3 S7 + 3 T141 + 6 T151
P7318	3 S7 + 9 T151
P7319	3 S7 + 6 T151 + 3 T161
P7320	3 S7 + 3 T151 + 6 T161
P7321	3 S7 + 9 T161
P7322	4 S7 + 6 T111 + 6 T131
P7323	4 S7 + 3 T111 + 9 T131
P7324	4 S7 + 12 T131
P7325	4 S7 + 3 T141 + 9 T131
P7326	4 S7 + 6 T131 + 6 T141
P7327	4 S7 + 3 T131 + 9 T141
P7328	4 S7 + 12 T141

REF. 4 niveles 4 levels 4 niveaux 4 Ebenen	DESGLOSE BREAKDOWN COMPOSITION AUFLISTUNG
P7329	1 S8 + 4 T61
P7330	1 S8 + 4 T71
P7331	1 S8 + 4 T81
P7332	1 S8 + 4 T91
P7333	1 S8 + 4 T101
P7334	1 S8 + 4 T111
P7335	1 S8 + 4 T131
P7336	1 S8 + 4 T141
P7337	1 S8 + 4 T151
P7338	1 S8 + 4 T161
P7339	2 S8 + 8 T81
P7340	2 S8 + 4 T81 + 4 T91
P7341	2 S8 + 8 T91
P7342	2 S8 + 4 T91 + 4 T101
P7343	2 S8 + 8 T101
P7344	2 S8 + 4 T101 + 4 T111
P7345	2 S8 + 8 T111
P7346	2 S8 + 4 T111 + 4 T131
P7347	2 S8 + 8 T131
P7348	2 S8 + 4 T131 + 4 T141
P7349	2 S8 + 8 T141
P7350	2 S8 + 4 T141 + 4 T151
P7351	2 S8 + 6 T151
P7352	2 S8 + 4 T151 + 4 T161
P7353	2 S8 + 8 T161
P7354	3 S8 + 8 T101 + 4 T111
P7355	3 S8 + 4 T101 + 8 T111
P7356	3 S8 + 12 T111
P7357	3 S8 + 8 T111 + 4 T131
P7358	3 S8 + 4 T111 + 8 T131
P7359	3 S8 + 12 T131
P7360	3 S8 + 8 T131 + 4 T141
P7361	3 S8 + 4 T131 + 8 T141
P7362	3 S8 + 12 T141
P7363	3 S8 + 8 T141 + 4 T151
P7364	3 S8 + 4 T141 + 8 T151
P7365	3 S8 + 12 T151
P7366	3 S8 + 8 T151 + 4 T161
P7367	3 S8 + 4 T151 + 8 T161
P7368	3 S8 + 12 T161
P7369	4 S8 + 8 T111 + 8 T131
P7370	4 S8 + 4 T111 + 12 T131
P7371	4 S8 + 16 T131
P7372	4 S8 + 4 T141 + 12 T131
P7373	4 S8 + 8 T131 + 8 T141
P7374	4 S8 + 4 T131 + 12 T141
P7375	4 S8 + 16 T141

REF. 5 niveles 5 levels 5 niveaux 5 Ebenen	DESGLOSE BREAKDOWN COMPOSITION AUFLISTUNG
P7376	1 S9 + 5 T61
P7377	1 S9 + 5 T71
P7378	1 S9 + 5 T81
P7379	1 S9 + 5 T91
P7380	1 S9 + 5 T101
P7381	1 S9 + 5 T111
P7382	1 S9 + 5 T131
P7383	1 S9 + 5 T141
P7384	1 S9 + 5 T151
P7385	1 S9 + 5 T161
P7386	2 S9 + 10 T81
P7387	2 S9 + 5 T81 + 5 T91
P7388	2 S9 + 10 T91
P7389	2 S9 + 5 T91 + 5 T101
P7390	2 S9 + 10 T101
P7391	2 S9 + 5 T101 + 5 T111
P7392	2 S9 + 10 T111
P7393	2 S9 + 5 T111 + 5 T131
P7394	2 S9 + 10 T131
P7395	2 S9 + 5 T131 + 5 T141
P7396	2 S9 + 10 T141
P7397	2 S9 + 5 T141 + 5 T151
P7398	2 S9 + 10 T151
P7399	2 S9 + 5 T151 + 5 T161
P7400	2 S9 + 10 T161
P7401	3 S9 + 10 T101 + 5 T111
P7402	3 S9 + 5 T101 + 10 T111
P7403	3 S9 + 15 T111
P7404	3 S9 + 10 T111 + 5 T131
P7405	3 S9 + 5 T111 + 10 T131
P7406	3 S9 + 15 T131
P7407	3 S9 + 10 T131 + 5 T141
P7408	3 S9 + 5 T131 + 10 T141
P7409	3 S9 + 15 T141
P7410	3 S9 + 10 T141 + 5 T151
P7411	3 S9 + 5 T141 + 10 T151
P7412	3 S9 + 15 T151
P7413	3 S9 + 10 T151 + 5 T161
P7414	3 S9 + 5 T151 + 10 T161
P7415	3 S9 + 15 T161
P7416	4 S9 + 10 T111 + 10 T131
P7417	4 S9 + 5 T111 + 15 T131
P7418	4 S9 + 20 T131
P7419	4 S9 + 5 T141 + 15 T131
P7420	4 S9 + 10 T131 + 10 T141
P7421	4 S9 + 5 T131 + 15 T141
P7422	4 S9 + 20 T141

FONDO 555 mm. Adaptable a GASTRONORM 1/1 / DEPTH 555 mm. Suitable for 1/1 GASTRONORM /
PROFONDEUR 555 mm. Adaptable aux GASTRONORME 1/1 / Tiefe 555 mm. Passend für Gastronorm 1/1

REF. 3 niveles 3 levels 3 niveaux 3 Ebenen	DESGLOSE BREAKDOWN COMPOSITION AUFLISTUNG	REF. 4 niveles 4 levels 4 niveaux 4 Ebenen	DESGLOSE BREAKDOWN COMPOSITION AUFLISTUNG	REF. 5 niveles 5 levels 5 niveaux 5 Ebenen	DESGLOSE BREAKDOWN COMPOSITION AUFLISTUNG
P7423	1 S1 + 3 T6	P7470	1 S2 + 4 T6	P7517	1 S3 + 5 T6
P7424	1 S1 + 3 T7	P7471	1 S2 + 4 T7	P7518	1 S3 + 5 T7
P7425	1 S1 + 3 T8	P7472	1 S2 + 4 T8	P7519	1 S3 + 5 T8
P7426	1 S1 + 3 T9	P7473	1 S2 + 4 T9	P7520	1 S3 + 5 T9
P7427	1 S1 + 3 T10	P7474	1 S2 + 4 T10	P7521	1 S3 + 5 T10
P7428	1 S1 + 3 T11	P7475	1 S2 + 4 T11	P7522	1 S3 + 5 T11
P7429	1 S1 + 3 T13	P7476	1 S2 + 4 T13	P7523	1 S3 + 5 T13
P7430	1 S1 + 3 T14	P7477	1 S2 + 4 T14	P7524	1 S3 + 5 T14
P7431	1 S1 + 3 T15	P7478	1 S2 + 4 T15	P7525	1 S3 + 5 T15
P7432	1 S1 + 3 T16	P7479	1 S2 + 4 T16	P7526	1 S3 + 5 T16
P7433	2 S1 + 6 T8	P7480	2 S2 + 8 T8	P7527	2 S3 + 10 T8
P7434	2 S1 + 3 T8 + 3 T9	P7481	2 S2 + 4 T8 + 4 T9	P7528	2 S3 + 5 T8 + 5 T9
P7435	2 S1 + 6 T9	P7482	2 S2 + 8 T9	P7529	2 S3 + 10 T9
P7436	2 S1 + 3 T9 + 3 T10	P7483	2 S2 + 4 T9 + 4 T10	P7530	2 S3 + 5 T9 + 5 T10
P7437	2 S1 + 6 T10	P7484	2 S2 + 8 T10	P7531	2 S3 + 10 T10
P7438	2 S1 + 3 T10 + 3 T11	P7485	2 S2 + 4 T10 + 4 T11	P7532	2 S3 + 5 T10 + 5 T11
P7439	2 S1 + 6 T11	P7486	2 S2 + 8 T11	P7533	2 S3 + 10 T11
P7440	2 S1 + 3 T11 + 3 T13	P7487	2 S2 + 4 T11 + 4 T13	P7534	2 S3 + 5 T11 + 5 T13
P7441	2 S1 + 6 T13	P7488	2 S2 + 8 T13	P7535	2 S3 + 10 T13
P7442	2 S1 + 3 T13 + 3 T14	P7489	2 S2 + 4 T13 + 4 T14	P7536	2 S3 + 5 T13 + 5 T14
P7443	2 S1 + 6 T14	P7490	2 S2 + 8 T14	P7537	2 S3 + 10 T14
P7444	2 S1 + 3 T14 + 3 T15	P7491	2 S2 + 4 T14 + 4 T15	P7538	2 S3 + 5 T14 + 5 T15
P7445	2 S1 + 6 T15	P7492	2 S2 + 8 T15	P7539	2 S3 + 10 T15
P7446	2 S1 + 3 T15 + 3 T16	P7493	2 S2 + 4 T15 + 4 T16	P7540	2 S3 + 5 T15 + 5 T16
P7447	2 S1 + 6 T16	P7494	2 S2 + 8 T16	P7541	2 S3 + 10 T16
P7448	3 S1 + 6 T10 + 3 T11	P7495	3 S2 + 8 T10 + 4 T11	P7542	3 S3 + 10 T10 + 5 T11
P7449	3 S1 + 3 T10 + 6 T11	P7496	3 S2 + 4 T10 + 8 T11	P7543	3 S3 + 5 T10 + 10 T11
P7450	3 S1 + 9 T11	P7497	3 S2 + 12 T11	P7544	3 S3 + 15 T11
P7451	3 S1 + 6 T11 + 3 T13	P7498	3 S2 + 8 T11 + 4 T13	P7545	3 S3 + 10 T11 + 5 T13
P7452	3 S1 + 3 T11 + 6 T13	P7499	3 S2 + 4 T11 + 8 T13	P7546	3 S3 + 5 T11 + 10 T13
P7453	3 S1 + 9 T13	P7500	3 S2 + 12 T13	P7547	3 S3 + 15 T13
P7454	3 S1 + 6 T13 + 3 T14	P7501	3 S2 + 8 T13 + 4 T14	P7548	3 S3 + 10 T13 + 5 T14
P7455	3 S1 + 3 T13 + 6 T14	P7502	3 S2 + 4 T13 + 8 T14	P7549	3 S3 + 5 T13 + 10 T14
P7456	3 S1 + 9 T14	P7503	3 S2 + 12 T14	P7550	3 S3 + 15 T14
P7457	3 S1 + 6 T14 + 3 T15	P7504	3 S2 + 8 T14 + 4 T15	P7551	3 S3 + 10 T14 + 5 T15
P7458	3 S1 + 3 T14 + 6 T15	P7505	3 S2 + 4 T14 + 8 T15	P7552	3 S3 + 5 T14 + 10 T15
P7459	3 S1 + 9 T15	P7506	3 S2 + 12 T15	P7553	3 S3 + 15 T15
P7460	3 S1 + 6 T15 + 3 T16	P7507	3 S2 + 8 T15 + 4 T16	P7554	3 S3 + 10 T15 + 5 T16
P7461	3 S1 + 3 T15 + 6 T16	P7508	3 S2 + 4 T15 + 8 T16	P7555	3 S3 + 5 T15 + 10 T16
P7462	3 S1 + 9 T16	P7509	3 S2 + 12 T16	P7556	3 S3 + 15 T16
P7463	4 S1 + 6 T11 + 6 T13	P7510	4 S2 + 8 T11 + 8 T13	P7557	4 S3 + 10 T11 + 10 T13
P7464	4 S1 + 3 T11 + 9 T13	P7511	4 S2 + 4 T11 + 12 T13	P7558	4 S3 + 5 T11 + 15 T13
P7465	4 S1 + 12 T13	P7512	4 S2 + 16 T13	P7559	4 S3 + 20 T13
P7466	4 S1 + 3 T14 + 9 T13	P7513	4 S2 + 4 T14 + 12 T13	P7560	4 S3 + 5 T14 + 15 T13
P7467	4 S1 + 6 T13 + 6 T14	P7514	4 S2 + 8 T13 + 8 T14	P7561	4 S3 + 10 T13 + 10 T14
P7468	4 S1 + 3 T13 + 9 T14	P7515	4 S2 + 4 T13 + 12 T14	P7562	4 S3 + 5 T13 + 15 T14
P7469	4 S1 + 12 T14	P7516	4 S2 + 16 T14	P7563	4 S3 + 20 T14