



**CARROS /  
TROLLEYS /  
CHARIOTS /  
SERVIERWAGEN**

<b>7.1</b>	<b>CARROS DE SERVICIO ALUMINIO / ALUMINIUM SERVING TROLLES / CHARIOTS DE SERVICE EN ALUMINIUM / SERVIERWAGEN AUS ALUMINIUM</b>	<b>200</b>
<b>7.2</b>	<b>CARROS DE SERVICIO ACERO INOXIDABLE / ST/STEEL SERVING TROLLEYS / CHARIOTS DE SERVICE EN ACIER INOXYDABLE / SERVIERWAGEN AUS EDELSTAHL</b>	<b>201</b>
<b>7.3</b>	<b>CARROS GUÍAS EN ACERO INOXIDABLE / ST/STEEL RAIL TROLLEYS / CHARIOTS À GLISSIÈRES EN ACIER INOXYDABLE / SERVIERWAGEN MIT EINSCHÜBEN AUS EDELSTAHL</b>	<b>204</b>
<b>7.4</b>	<b>CARROS ESPECIALES / SPECIAL TROLLEYS / CHARIOTS SPÉCIAUX / SPEZIALWAGEN</b>	<b>210</b>

**P8090** Carro aluminio desembarace / Aluminium clearing trolley /  
Chariot débarrasse en aluminium / Aluminium Abräumwagen

**EXCLUSIVE**



REF	
P80.900	1

Medidas de estantes adaptables a cubetas GN 1/1 y cestas FLAP-RACK® (500 x 500 mm). Carga máxima: total 150 Kg y con un máximo de 75 Kg por estante.

Racks adjustable to 1/1 GN containers and FLAP-RACK® (500 x 500 mm). Maximum load: 150 Kg and max. per level 75 Kg.

Clayettes adaptables à des bacs GN 1/1 et à casiers à vaisselle FLAP-RACK® (500 x 500 mm). Charge maximale: total 150 Kg et 75 Kg par niveau.

Masse der regale passend für GN behälter 1/1 und FLAP-RACK® spülkörbe (500 x 500 mm). Maximale tragkraft: total 150 Kg und maximal 75 Kg pro regal.

**P6411** Carro de servicio / Trolley / Chariot de service / Servierwagen



REF	DIM. ESTANTE / SHELF DIMENTION / DIM. NIVEAU / REGALGRÖSSE mm	
P641.100	780 x 485	1

Carga máxima 120 kgs  
Maximum weight load 120 kgs  
Charge maximale 120 kgs  
Maximale Tragkraft 120 kg

Soportes de aluminio  
Aluminium supports  
Supports en aluminium  
Aluminiumständer

**P642 / P643** Contenedor para cubiertos / Silverware container / Conteneur pour couverts / Besteckkasten  
Contenedor para desperdicios / Refuse container / Conteneur pour déchets / Abfalleimer



REF	cm	Lts	
P642.000	32 x 19,5 x 16,5	9,00	1
P643.000	33,5 x 23 x 56	80,00	1

**P640** Conjunto carro / Set trolley / Ensemble chariot / Servierwagenset



REF	DIM. ESTANTE / SHELF DIMENTION / DIM. NIVEAU / REGALGRÖSSE mm	
P640.000	780 x 485	1

ESTRUCTURA TUBULAR EN ACERO INOX DE 1.5 MM ESPESOR /  
1.5 MM THICK ST/STEEL TUBULAR FRAME /  
STRUCTURE TUBULAIRE EN ACIER INOXYDABLE 1.5 MM. EPAISSEUR /  
STRUKTUR AUS EDELSATHLROHR VON 1,5 MM DICKE.



CARGA MÁXIMA TOTAL 250 KG. CARGA MÁXIMA POR ESTANTE 80 KG /  
TOTAL MAXIMUM LOAD 250 KG. MAX. LOAD PER LEVEL 80 KG /  
CHARGE MAXIMALE TOTAL 250 KG. CHARGE MAXIMALE PER NIVEAU 80 KG /  
MAXIMALE TRAGKRAFT: TOTAL 250 KG UND MAX 80 KG PRO REGAL.

RUEDAS GIRATORIAS DE 12 CM DIÁMETRO. DOS CON FRENOS /  
12 CM DIAM. REVOLVING CASTERS. TWO WITH BRAKES /  
ROUES GIRATOIRES DE 12 CM DIAM. DEUX AVEC FREINS /  
DREHBARE RÄDER 12 CM DURCHMESSER. ZWEI MIT BREMSVORRICHTUNG



**P8024** Carro servicio acero inox / St/steel serving trolley /  
Chariot service en acier inox / Servierwagen Edelstahl

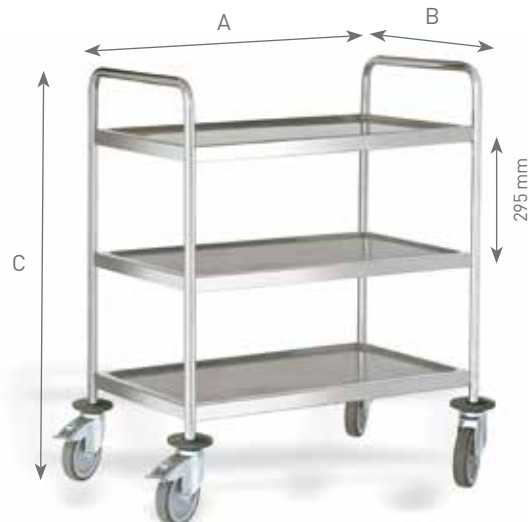
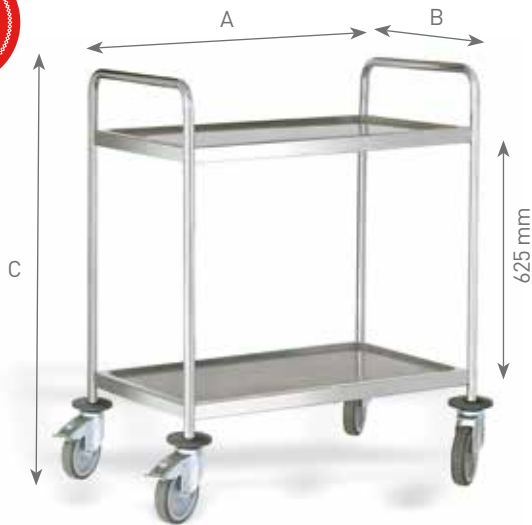

REF	ESTANTES / LEVELS / NIVEAUX / REGALE	DIM. ESTANTE / SHELF DIMENTION / DIM. NIVEAU / REGALGRÖSSE mm	A x B x C mm	
P80.240	2	800 x 500	880 x 580 x 1015	1
P80.250	2	900 x 500	980 x 580 x 1015	1
P80.260*	2	1000 x 600	1080 x 680 x 1015	1
P80.270	3	800 x 500	880 x 580 x 1015	1
P80.280	3	900 x 500	980 x 580 x 1015	1
P80.290*	3	1000 x 600	1080 x 680 x 1015	1
P80.300	4	800 x 500	880 x 580 x 1300	1
P80.310	4	900 x 500	980 x 580 x 1300	1
P80.320*	4	1000 x 600	1080 x 680 x 1300	1

\*Estantes de chapa de mayor espesor / Thicker shelves /  
Plateaux plus épais / Regal aus dickerem Blech.

Disponible también con ruedas poliamida. Consultar precio.  
Available also on polyamide castors. Please ask for price.  
Disponible aussi avec roulettes polyamide. Consulter prix.  
Auch lieferbar mit Polyamidrädern. Bitte Preis nachfragen.

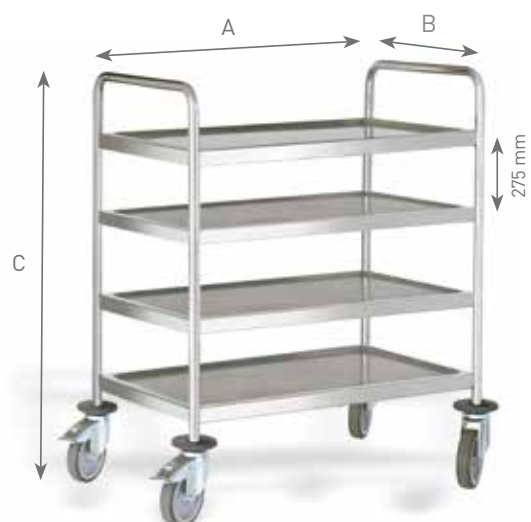



SE ENTREGAN DESMONTADOS. MUY ROBUSTOS Y SÓLIDOS / DELIVERED FLATPACKED. VERY STRONG AND RESISTANT ONCE ASSEMBLED / LIVRÉS DÉMONTÉS. TRÈS ROBUSTES ET SOLIDES UNE FOIS MONTÉS / LIEFERUNG UNMONTIERT. EINMAL MONTIERT SIND SIE SEHR ROBUST UND SOLIDE

MONTAJE / ASSEMBLY / MONTAGE / MONTAGE



CARGA MÁXIMA TOTAL 250 KG. CARGA MÁXIMA POR ESTANTE 80 KG / TOTAL MAXIMUM LOAD 250 KG. MAX. LOAD PER LEVEL 80 KG / CHARGE MAXIMALE TOTAL 250 KG. CHARGE MAXIMALE PER NIVEAU 80 KG / MAXIMALE TRÄGKRAFT: TOTAL 250 KG UND MAX 80 KG PRO REGAL

RUEDAS GIRATORIAS DE 12 CM DIÁMETRO. DOS CON FRENOS / 12 CM DIAM. REVOLVING CASTERS. TWO WITH BRAKES / ROUES GIRATOIRES DE 12 CM DIAM. DEUX AVEC FREINS / DREHBARE RÄDER 12 CM DURCHMESSER. ZWEI MIT BREMSVORRICHTUNG



**P8033** Carro desmontable / Disassembled trolley / Chariot démontable / Demontierbarer Servierwagen

REF	ESTANTES / LEVELS / NIVEAUX / REGALE	DIM. ESTANTE / SHELF DIMENTION / DIM. NIVEAU / REGALGRÖSSE mm	A x B x C mm	
P80.330	2	800 x 500	810 x 545 x 1040	1
P80.340	2	900 x 500	910 x 545 x 1040	1
P80.350	3	800 x 500	810 x 545 x 1040	1
P80.360	3	900 x 500	910 x 545 x 1040	1



**P8096** Carro desmontable ligero / Light disassembled trolley / Chariot démontable légère / Leichter demontierbarer Servierwagen

Ruedas acero Ø 100 mm. Dos con freno. Castors Ø 100 mm. Two with brakes. Roulettes Ø 100 mm. Deux avec freins. Edelstahlräder Ø 100 mm. Zwei mit Bremsen.

REF	ESTANTES / LEVELS / NIVEAUX / REGALE	DIM. ESTANTE / SHELF DIMENTION / DIM. NIVEAU / REGALGRÖSSE mm	
P80.960	2	830 x 510	1
P80.961	3	830 x 510	1

GAMA ECONÓMICA / ECONOMIC LINE / GAMME ECONOMIQUE / ÖKONOMISCHE SERIE



**P8094** Carro servicio con barandilla / Serving trolley with guard-rail shelf /  
Chariot service avec galerie / Servierwagen mit Geländer



REF	ESTANTES / LEVELS / NIVEAUX / REGALE	DIM. ESTANTE / SHELF DIMENTION / DIM. NIVEAU / REGALGRÖSSE mm	
P80.940	2	800 x 500	1
P80.941	3	800 x 500	1

Disponibile también con ruedas poliamida. Consultar precio /  
Available also on polyamide castors. Please ask for price /  
Disponibile aussi avec roulettes polyamide. Consulter prix /  
Auch lieferbar mit Polyamidrädern. Bitte Preis nachfragen.

**P8068** Carro desembarace inox / St/Steel clearing trolley /  
Chariot de débarrassage en inox / Abräumwagen



REF	ESTANTES / LEVELS / NIVEAUX / REGALE	DIM. ESTANTE / SHELF DIMENTION / DIM. NIVEAU / REGALGRÖSSE mm	
P80.680	2	1.000 x 600	1

Disponibile también con ruedas poliamida. Consultar precio.  
Available also on polyamide castors. Please ask for price.  
Disponibile aussi avec roulettes polyamide. Consulter prix.  
Auch lieferbar mit Polyamidrädern. Bitte Preis nachfragen.

No incluye cubeta Gastronorm 1/2.  
1/2 Gastronorm container not included.  
Bac Gastronorme 1/2 non inclus.  
1/2 Gastronorm Behälter nicht im Preis inklusive.

Ø 165 mm

Cubertero para carro servicio /  
Cutlery dispenser for serving trolley /  
Ramasse-couverters pour chariot service /  
Behälter für Servicewagen

**P80374**



REF	Mod	H mm	
P80.374	GN 1/3	150	1

VER PRODUCTOS EN / SEE PRODUCTS ON /  
VOIR PRODUITS EN PAGE / SIEHE PRODUKTE IN

CARRO MADERA PRESENTACIÓN BUFFET /  
WOODEN BUFFET SERVING TROLLEY /  
CHARIOT BUFFET EN BOIS PRÉS. BUFFET /  
BUFFETSERVIERWAGEN AUS HOLZ



P. 444

**P8043** Carro 17 guías GN 1/1 / 17 rails trolley for 1/1 GN pans /  
Chariot 17 glissières pour bacs GN 1/1 / Servierwagen mit 17 Einschüben für GN 1/1



REF	
P80.430	1

Entrada 325 mm  
Entrance 325 mm  
Entrée 325 mm  
Eingang 325 mm

Disponible también con ruedas poliamida. Consultar precio.  
Available also on polyamide castors. Please ask for price.  
Disponible aussi avec roulettes polyamide. Consulter prix.  
Auch lieferbar mit Polyamidrädern. Bitte Preis nachfragen.

**P8067** Carro doble 17 x 2 guías 1/1 / Double rail trolley 17 x 2 for 1/1 GN pans /  
Chariot double 17 x 2 glissières pour bacs GN 1/1 / Doppelservierwagen mit 17 x 2 Einschüben für GN 1/1



REF	
P80.670	1

Entrada 325 mm  
Entrance 325 mm  
Entrée 325 mm  
Eingang 325 mm

Disponible también con ruedas poliamida. Consultar precio.  
Available also on polyamide castors. Please ask for price.  
Disponible aussi avec roulettes polyamide. Consulter prix.  
Auch lieferbar mit Polyamidrädern. Bitte Preis nachfragen.

VER PRODUCTOS EN / SEE PRODUCTS ON / VOIR PRODUITS EN PAGE / SIEHE PRODUKTE IN

BANDEJAS GN Y PASTELERÍA /  
GN AND BAKING SHEET PANS /  
PLAQUES GN ET PÂTISSERIE /  
GN-TABLETTES UND BACKWAREN



P. 70, 72

**P8052** Carro encastrable 17 guías GN 1/1 / Stackable trolley 17 rails for 1/1 GN pans /  
Chariot emboîtable 17 glissières pour bacs GN 1/1 / Klappbarer Servierwagen mit 17 Einschüben für GN 1/1

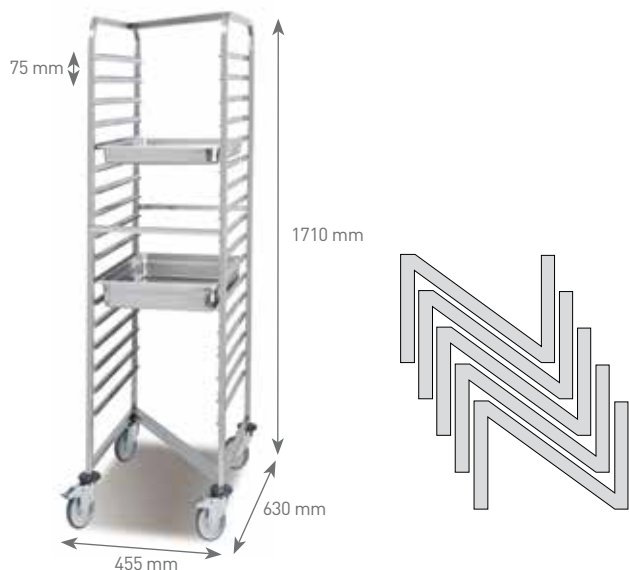

REF	
P80.520	1

Entrada 325 mm  
Entrance 325 mm  
Entrée 325 mm  
Eingang 325 mm

Disponible también con ruedas poliamida. Consultar precio.  
Available also on polyamide castors. Please ask for price.  
Disponibile aussi avec roulettes polyamide. Consulter prix.  
Auch lieferbar mit Polyamidrädern. Bitte Preis nachfragen.

**P8047** Carro desmontable 17 guías GN 1/1 / Disassembled trolley 17 rails for 1/1 GN pans /  
Chariot démontable 17 glissières pour bacs GN 1/1 / Demontierbarer Servierwagen mit 17 Einschüben für GN 1/1



REF	
P80.470	1

Entrada 325 mm  
Entrance 325 mm  
Entrée 325 mm  
Eingang 325 mm

Disponible también con ruedas poliamida. Consultar precio.  
Available also on polyamide castors. Please ask for price.  
Disponibile aussi avec roulettes polyamide. Consulter prix.  
Auch lieferbar mit Polyamidrädern. Bitte Preis nachfragen.

Desmontado /  
Flat packed /  
Livré démonté /  
Demontiert

**P8097** Carro desmontable ligero 15 guías GN 1/1 /  
Light Disassembled trolley 15 rails for 1/1 GN pans /  
Chariot démontable léger 15 glissières pour bacs GN 1/1 /  
Leichter Demontierbarer Servierwagen mit 15 Einschüben für GN 1/1



REF	
P80.970	1

Entrada 325 mm  
Entrance 325 mm  
Entrée 325 mm  
Eingang 325 mm

Ruedas acero Ø 120 mm. Dos con freno.  
Castors Ø 120 mm. Two with brakes.  
Roulettes Ø 120 mm. Deux avec freins.  
Edelstahlrollen Ø 120 mm. Zwei mit Bremsen.

GAMA ECONÓMICA /  
ECONOMIC LINE /  
GAMME ECONOMIQUE /  
ÖKONOMISCHE SERIE



**P8044** Carro 17 guías GN 2/1 / 17 rails trolley for 2/1 GN pans /  
Chariot 17 glissières pour bacs GN 2/1 / Servierwagen mit 17 Einschüben für GN 2/1



REF	
P80.440	1

Entrada 530 mm  
Entrance 530 mm  
Entrée 530 mm  
Eingang 530 mm

Disponible también con ruedas poliamida. Consultar precio.  
Available also on polyamide castors. Please ask for price.  
Disponibile aussi avec roulettes polyamide. Consulter prix.  
Auch lieferbar mit Polyamidrädern. Bitte Preis nachfragen.

**P8048** Carro desmontable 17 guías GN 2/1 / Disassembled trolley 17 rails for 2/1 GN pans /  
Chariot démontable 17 glissières pour bacs GN 2/1 / Demontierbarer Servierwagen mit 17 Einschüben für GN 2/1



Desmontado /  
Flat packed /  
Livré démonté /  
Demontiert

REF	
P80.480	1

Entrada 530 mm  
Entrance 530 mm  
Entrée 530 mm  
Eingang 530 mm

Disponibile también con ruedas poliamida. Consultar precio.  
Available also on polyamide castors. Please ask for price.  
Disponibile aussi avec roulettes polyamide. Consulter prix.  
Auch lieferbar mit Polyamidrädern. Bitte Preis nachfragen.

**P8051** Carro encastrable 17 guías GN 2/1 / Stackable trolley 17 rails for 2/1 GN pans /  
Chariot emboîtable 17 glissières pour bacs GN 2/1 / Klappbarer Servierwagen mit 17 Einschüben für GN 2/1

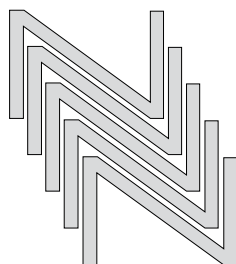

REF	
P80.510	1

Entrada 530 mm  
Entrance 530 mm  
Entrée 530 mm  
Eingang 530 mm

Disponibile también con ruedas poliamida. Consultar precio.  
Available also on polyamide castors. Please ask for price.  
Disponibile aussi avec roulettes polyamide. Consulter prix.  
Auch lieferbar mit Polyamidrädern. Bitte Preis nachfragen.

**P8084 / P8085 / P8046** Carro pastelería / Pastry trolley / Chariot pâtisserie / Patisseriewagen



REF	MEDIDA GUÍAS / SIZE OF RAILS / DIMENSIONS GLISSIÈRES / EINSCHUBGRÖSSEN mm	Nº GUÍAS / NR. OF LEVELS / NUM. NIVEAUX / NR. EINSCHÜBE	DISTANCIA ENTRE GUÍAS / DISTANCE BETWEEN LEVELS / ESPACE ENTRE NIVEAUX / EINSCHUBABSTÄNDE mm	
P80.840	600 x 400	15	85	1
P80.850	600 x 400	20	70	1
P80.460	600 x 400	30	45	1

Entrada 400 mm  
Entrance 400 mm  
Entrée 400 mm  
Eingang 400 mm

Disponible también con ruedas poliamida. Consultar precio.  
Available also on polyamide castors. Please ask for price.  
Disponibile aussi avec roulettes polyamide. Consulter prix.  
Auch lieferbar mit Polyamidrädern. Bitte Preis nachfragen.

**Carro desmontable bandejas pastelería /  
Disassembled rail trolley for bakery /  
Chariots démontable pour plaques à pâtisserie /  
Demontierbarer Wagen für Patisserietablets**

**P8087 / P8088 / P8050**



REF	MEDIDA GUÍAS / SIZE OF RAILS / DIMENSIONS GLISSIÈRES / EINSCHUBGRÖSSEN mm	Nº GUÍAS / NR. OF LEVELS / NUM. NIVEAUX / NR. EINSCHÜBE	DISTANCIA ENTRE GUÍAS / DISTANCE BETWEEN LEVELS / ESPACE ENTRE NIVEAUX / EINSCHUBABSTÄNDE mm	
P80.870	600 x 400	15	85	1
P80.880	600 x 400	20	70	1
P80.500	600 x 400	30	45	1

Entrada 400 mm  
Entrance 400 mm  
Entrée 400 mm  
Eingang 400 mm

Disponible también con ruedas poliamida. Consultar precio.  
Available also on polyamide castors. Please ask for price.  
Disponibile aussi avec roulettes polyamide. Consulter prix.  
Auch lieferbar mit Polyamidrädern. Bitte Preis nachfragen.

Desmontado / Flat packed /  
Livré démonté / Demontiert

**P8053** Carro encastrable pastelería 15 guías / Stackable pastry trolley 15 rails /  
Chariot emboîtable pâtisserie 15 glissières / Klappbarer Patisseriewagen 15 Einschübe

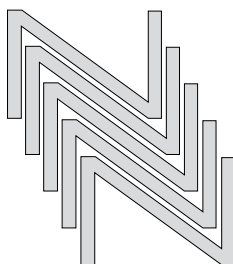

REF	
P80.530	1

Disponibile también con ruedas poliamida. Consultar precio.  
Available also on polyamide castors. Please ask for price.  
Disponibile aussi avec roulettes polyamide. Consulter prix.  
Auch lieferbar mit Polyamidrädern. Bitte Preis nachfragen.

**P8081** Carro descongelación 9 guías / Defrost trolley 9 rails /  
Chariot à dégivrage 9 glissières / Auftauwagen mit 9 Einschüben

**PATENTED EXCLUSIVE**



REF	Mod	A x B x C mm	
P80.810	GN 2/1	665 x 755 x 1720	1
P80.813	GN 1/1	455 x 635 x 1720	1

Ahorro de espacio en el proceso de descongelado de los alimentos.  
Space saver while foodstuff defrost.  
Economie d'espace pendant le dégivrage des aliments.  
Platzsparend im Auftauverfahren von Lebensmitteln.

Disponible también con ruedas poliamida. Consultar precio.  
Available also on polyamide castors. Please ask for price.  
Disponible aussi avec roulettes polyamide. Consulter prix.  
Auch lieferbar mit Polyamidrädern. Bitte Preis nachfragen.

**P80811** Cubeta especial GN para carro descongelación / Special GN container for defrost trolley /  
Bac GN spécial pour chariot dégivrage / Spezial GN Behälter zum Auftauen



REF	Mod	mm	Lts	H mm	
P80.811	GN 2/1	650 x 530	28,90	100,0	1
P80.814	GN 1/1	530 x 325	14,20	100,0	1

Cubeta con desagüe.  
Container with drainer hole.  
Bac avec dégorgeement.  
Behälter mit Abwasserloch.

**P215 / P115** Fondo perforado para cubeta / Perforated bottom /  
Egouttoir pour bac / Gelochter Einlegeboden für Behälter



REF	Mod	
P215.000 <sup>1</sup>	GN 2/1	1
P115.000 <sup>2</sup>	GN 1/1	1

<sup>1</sup> Recomendado para ref. P80811  
Recommended for item code P80811  
Recommandé pour réf. P80811  
Empfohlen für Art.Nr. P80811

<sup>2</sup> Recomendado para ref. P80814  
Recommended for item code P80814  
Recommandé pour réf. P80814  
Empfohlen für Art.Nr. P80814

VER PRODUCTOS EN / SEE PRODUCTS ON / VOIR PRODUITS EN PAGE / SIEHE PRODUKTE IN

REJILLAS / GRIDS /  
GRILLES / ROSTE

P. 74



**P8095** Carro self-service 12 guías / Self-service trolley 12 rails /  
Chariot self-service 12 glissières / Selbstbedienungswagen 12 Einschübe



REF		
P80.950		1
P80.951*		1

Para bandejas de ancho 365 mm hasta 420 mm  
For trays from 365 mm to 420 mm width  
Pour plateaux de 365 mm à 420 mm  
Für Tablettts der Breite von 365 mm bis 420 mm.

- \* Con dos paneles laterales composite+aluminio.
- \* With two side panels made of aluminium+composite .
- \* Avec deux panneaux latéraux en composite+aluminium.
- \* Mit zwei Seitenwänden aus composite+Aluminium.

**P8091** Carro doble para bandejas fast-food 12 guías / Double fast-food tray trolley 12 rails /  
Chariot double pour plateaux fast-food 12 glissières / Doppelwagen für Fast-Food Tablettts 12 Einschübe



REF	MEDIDA GUÍAS / SIZE OF RAILS / DIMENSIONS GLISSIÈRES / EINSCHÜBGRÖSSE mm	
P80.910	480 x 800	1

Entrada 480 mm  
Entrance 480 mm  
Entrée 480 mm  
Eingang 480 mm

Ideal para bandejas 480 x 370 mm  
Suitable for trays 480 x 370 mm  
Ideal pour plateaux 480 x 370 mm  
Ideal für Tablettts 480 x 370 mm

Disponible también con ruedas poliamida. Consultar precio.  
Available also on polyamide castors. Please ask for price.  
Disponible aussi avec roulettes polyamide. Consulter prix.  
Auch lieferbar mit Polyamidrädern. Bitte Preis nachfragen.

**P925** Carro transporte bandejas isotérmicas / Transport trolley for isothermal trays /  
Chariot transport plateaux isothermes / Transportwagen für isothermische Tablettts



REF	MEDIDA GUÍAS / SIZE OF RAILS / DIMENSIONS GLISSIÈRES / EINSCHÜBGRÖSSEN mm	Nº GUÍAS / NR. OF LEVELS / NUM. NIVEAUX / NR. EINSCHÜBE	
P925.001	550 x 375	10	1
P925.002	550 x 375	20	1

Carro fabricado en acero inoxidable y guías de plástico. Ideal para el transporte de bandejas de distintas medidas, gracias al diseño especial de sus guías. Ruedas giratorias insonoras de Ø 125 mm.

Chariot fabriqué en acier inoxydable et glissières en plastique. Idéal pour le transport des plateaux de différentes mesures, grâce au design spécial des glissières. Roulettes insonores de Ø 125 mm.

Trolley made of St/Steel and plastic rails. Perfect for many different size trays transport thanks to the special rail design. Soundproof revolving castors Ø 125 mm.

Wagen hergestellt aus rostfreiem Stahl mit Plastikeinschüben. Ideal für den Transport von Tablettts verschiedener Größen, dank seinem speziellen Design der Einschübe. Geräuschlose drehbare Räder Ø 125 mm.

**P8039** Carro porta cubetas GN / GN containers transport trolley /  
Chariot transport bacs GN / Transportwagen für GN Behälter



REF	
P80.390	1

No incluye cubetas GN.  
GN containers not included.  
Bacs GN non inclus.  
GN Behälter nicht inklusive.

Disponible también con ruedas poliamida. Consultar precio.  
Available also on polyamide castors. Please ask for price.  
Disponible aussi avec roulettes polyamide. Consulter prix.  
Auch lieferbar mit Polyamidrädern. Bitte Preis nachfragen.

**P8038** Carro porta cubeta GN 2/1 / 2/1 GN transport trolley /  
Chariot transport bac GN 2/1 / Transportwagen für GN Behälter 2/1



REF	
P80.380	1

No incluye cubetas GN.  
GN containers not included.  
Bacs GN non inclus.  
GN Behälter nicht inklusive.

Disponible también con ruedas poliamida. Consultar precio.  
Available also on polyamide castors. Please ask for price.  
Disponible aussi avec roulettes polyamide. Consulter prix.  
Auch lieferbar mit Polyamidrädern. Bitte Preis nachfragen.

REF. P80.390 / P80.380  
CARRO TRANSPORTE PARA CUBETAS GN  
TRANSPORT TROLLEY FOR GN CONTAINERS  
CHARIOTS DE TRANSPORT POUR BACS GN  
TRANSPORTWAGEN FÜR GN BAEHÄLTER

Fabricados en acero inoxidable. Ideales para el almacenaje y transporte de alimentos preparados y salsas en grandes cantidades.  
Made of St/Steel. Perfect for storing and transporting large quantities of prepared food and sauces.  
Fabriqués en acier inoxydable. Idéales pour le stockage et le transport d'aliments cuisinés et sauces en grandes quantités.  
Hergestellt aus Edelstahl. Ideal für die Lagerung und den Transport von vorbereiteten Lebensmittel und Sossen in grossen Mengen.

**P8074** Carro portacubiertos GN 1/3 y porta bandejas / Trolley cutlery dispenser GN 1/3 /  
Chariot porte-ramasse couverts GN 1/3 / Transportwagen für GN 1/3 Besteckbehälter und Tablett



REF	
P80.740	1

No incluye cubetas GN.  
GN containers not included.  
Bacs GN non inclus.  
GN Behälter nicht inklusive.

Disponible también con ruedas poliamida. Consultar precio.  
Available also on polyamide castors. Please ask for price.  
Disponible aussi avec roulettes polyamide. Consulter prix.  
Auch lieferbar mit Polyamidrädern. Bitte Preis nachfragen.

**P8057** Carro para cargas pesadas / Trolley for heavy loads / Chariot à charges lourdes / Wagen für schwere Last



REF	
P80.570	1

Carga máxima: 350 kg  
Maximum load: 350 kg  
Charge maximale: 350 kg  
Maximale Tragkraft: 350 kg

**P8054** Carro transporte bandejas 7 guías / Tray transport trolley 7 rails / Chariot transport plateaux 7 glissières / Tabletttransportwagen 7 Einschübe

REF	MEDIDA GUÍAS / SIZE OF RAILS / DIMENSIONS GLISSIÈRES / EINSCHUBGRÖSSEN mm	A x B x C mm	DISTANCIA ENTRE GUÍAS / DISTANCE BETWEEN LEVELS / ESPACE ENTRE NIVEAUX / EINSCHUBABSTAND mm	
P80.540	GN 1/1	455 x 635 x 900	75	1
P80.550	GN 2/1	660 x 750 x 900	75	1
P80.560	Pastelería / Pastry / Pâtisserie / Patisserie (600 x 400 mm)	525 x 700 x 900	85	1
P80.780	GN 1/1 Doble	810 x 635 x 900	75	1

Ref. P80.540

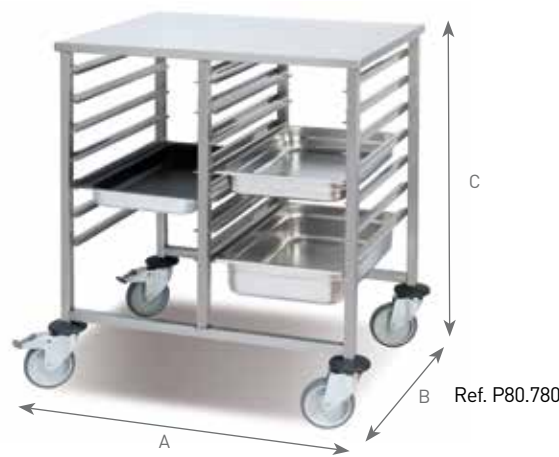

Disponible también con ruedas poliamida. Consultar precio.  
Available also on polyamide castors. Please ask for price.  
Disponible aussi avec roulettes polyamide. Consulter prix.  
Auch lieferbar mit Polyamidrädern. Bitte Preis nachfragen.

**P8061 / P8062 / P8063** Fundas desechables de polietileno para carros (rollo de 100 unidades) / Disposable covers for trolleys (pack 100 pieces) / Housses jetables pour chariots (rouleau de 100 unités) / Einweghüllen aus Polyethylen für Wagen (Rollen von 100 Stück)





REF		
P80.610	para carro 1/1 / for trolley 1/1 / pour chariot 1/1 / für Wagen 1/1	1
P80.620	para carro 2/1 / for trolley 2/1 / pour chariot 2/1 / für Wagen 2/1	1
P80.630	para carro pastelería 600 x 400 / for pastry trolley 600 x 400 / pour chariot pâtisserie 600 x 400 / für Patisseriewagen 600 x 400	1
P80.640	dispensador / dispenser / distributeur / Rollenhalter	1

Polietileno de densidad media.  
Medium density polyethylene.  
Poliéthylène de densité moyenne.  
Polyethylen mittlere Stärke.

Para carros altos.  
For high trolleys.  
Pour chariots hauts.  
Für hohe Wagen.

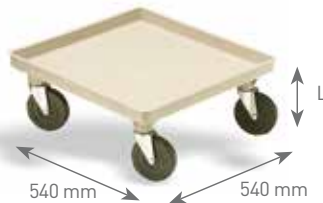
**P5015 / P5017** Carro de plástico para cestas / Plastic trolley for dishwasher racks /  
Chariot pour casiers à vaisselle / Plastikwagen für Spülkörbe



REF		L mm	
P5015	sin asa / without handle / sans anse / ohne Griff	230	1
P5017	con asa / with handle / avec anse / mit Griff	980	1

**P8058 / P8059** Carro inox para cestas / St/steel trolley for dishwasher racks /  
Chariot inox pour casiers à vaisselle / Edelstahlwagen für Spülkörbe

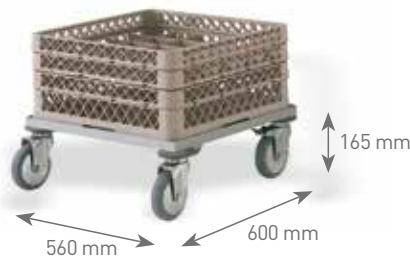

REF		
P80.590	sin asa / without handle / sans anse / ohne Griff	1
P80.580	con asa / with handle / avec anse / mit Griff	1

**P8075 / P8076 / P8077** Carro para cestas Vajillas / Dishwasher rack trolley /  
Chariot casiers à vaisselle / Wagen für Spülkörbe



REF	MEDIDA GUÍAS / SIZE OF RAILS / DIMENSIONS GLISSIÈRES / EINSCHUBGRÖSSEN mm	Nº GUÍAS / NR. OF LEVELS / NUM. NIVEAUX / NR. EINSCHÜBE	A x B x C mm	
P80.750	500 x 500	5	640 x 633 x 1160	1
P80.760	500 x 500	9	640 x 633 x 1710	1
P80.770	500 x 500 (doble/double)	9	1185 x 633 x 1710	1



CARRROS /  
TROLLEYS /  
CHARIOTS



**ADC-4** Carro ajustable para platos / Adjustable dish caddy /  
Chariot modulable pour assiettes / Einstellbarer Tellerwagen

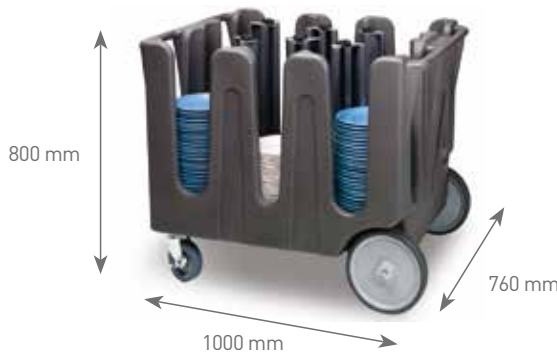

COMBINACIONES /  
COMBINATIONS /  
COMBINATIONS /  
KOMBINATIONEN

Tamaño platos  
Size plates  
Taille assiettes  
Tellergrösse

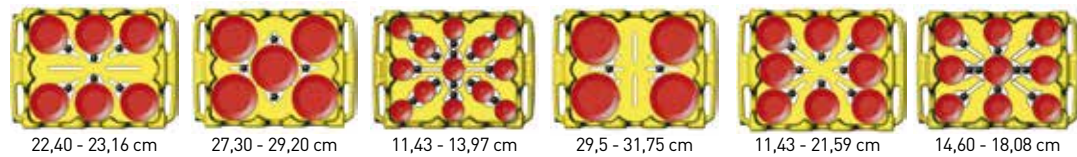

REF	
ADC-4	1

Se sirve con 4 columnas separadoras más una funda protectora.  
Delivered with 4 posts plus 1 protection cover.  
Livré avec 4 colonnes de séparation et 1 housse de protection.  
Lieferung mit 4 Unterteilungssäulen und einer Schutzhülle.

Ajuste único y fácil por la parte superior.  
Unique and easy adjustment from the top.  
Reglage unique et facile de la partie supérieure.  
Einzigartige und einfache Einstellung des Oberteils.

**SAC-SQ5-06** Carro ajustable para platos cuadrados y redondos / Adjustable caddy for square & round dishes /  
Chariot modulable pour assiettes carrées et rondes / Einstellbarer Wagen für runde und quadratische Teller



Diseño exclusivo apilable.  
Unique, stackable design.  
Design exclusif empilable.  
Exclusives Design stapelbar.

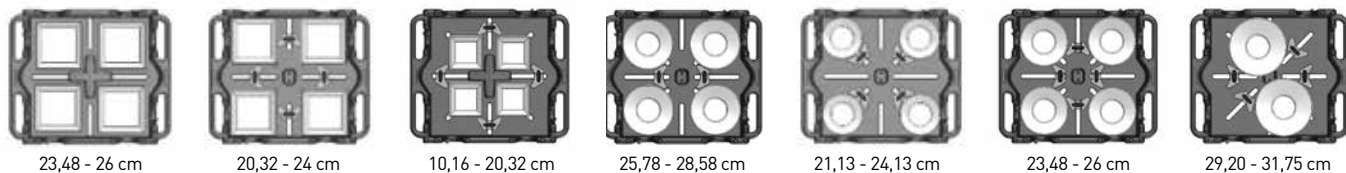

REF	
SAC-SQ5-06	1

Se sirve con 5 columnas separadoras una de ellas en forma de cruz más una funda protectora.  
Delivered with 5 posts, one of them in cross shape plus 1 protection cover.  
Livré avec 5 colonnes de séparation une desquelles en forme de croix plus 1 housse de protection.  
Lieferung mit 5 Unterteilungssäulen, eine von Ihnen in Kreuz-form und einer Schutzhülle.

**ADP** Columna separadora carro platos / Post for dish trolley /  
Colonne séparation chariot assiettes / Unterteilungssäule für Tellerwagen



REF	
ADP	1

Compatible ref: ADC-4 y SAC-SQ5-06.  
Compatible ref: ADC-4 & SAC-SQ5-06.  
Compatible réf: ADC-4 et SAC-SQ5-06.  
Passend für Art.Nr.: ADC-4 und SAC-SQ5-06.

**SAVC / ADVC** Funda protectora de vinilo para carro platos / Vinyl cover for dish trolley /  
Housse protection en vynil pour chariot assiettes / Vynilschutzhülle für Tellerwagen



REF	
SAVC	1
ADVC	1

SAVC. Funda para ref. / Cover for item / Housse pour réf. / Hülle für Art.Nr. ADC-4	ADVC. Funda para ref. / Cover for item / Housse pour réf. / Hülle für Art.Nr. SAC-SQ5-06
---	--

**ICE140-06** Carro hielo / Ice caddy / Chariot à glaçons / Eiswagen



REF	KG	cm	Hcm	
ICE140-06	63,5	91,5 x 70	77,5	1



VER PRODUCTOS EN / SEE PRODUCTS ON / VOIR PRODUITS EN PAGE / SIEHE PRODUKTE IN



P. 319